

ROCK SOLID

*- American Made
Since 1946!*



2017
Product
Catalog



REDDING

RELOADING EQUIPMENT

ROCK SOLID – American Made . . .

It's who we are!

For seven decades, we have been dozens of Americans finding success in a traditional manufacturing business in rural, Upstate New York.

We are Mothers, Fathers, Grandparents, Great Grandparents, Brothers and Sisters. We are Veterans, First Responders, Firefighters, and Community Volunteers.

We are also hunters and target shooters, concealed carry permit holders, Hunter Safety Instructors and believers in the freedoms upon which this country was founded. Each one of us make the equipment contained in this catalog under one roof, in one plant, to one quality standard which is still the envy of the world.

We are proud to live in this great nation and we each share a commitment to do our jobs by making the best reloading equipment to be had anywhere in the world, That is why, with no hesitation, we offer you our Lifetime Warranty.

Today we reflect on the truly American traditions we have been blessed to be a witness to; the generations of families who have worked here, Sons and Daughters and even Grandchildren taking up where their elders left off. Employees with 30 and even 40 years of service who came here and never left. And finally, to see what that kind of individual commitment has brought to the world market, securing America's leading role in reloading.

. . . The Redding Team



See What's New . . .



New!

Premium Die Sets

Now available – 22 Nosler & 6.5 Creedmoor
See Page 16

Additional!

Bushing Style Dies and Competition Seaters

See Pages 8 & 9

New!

Master Hunter Die Sets

Now available – 22 Nosler, 6.5 Creedmoor and 33 Nosler
See Page 17

New! Turret Stacker

A convenient system for storing extra turret heads. Supplied with an assortment of spacers allowing up to three turrets to be stacked with dies installed, thus preserving their adjustment. This system also prevents damage to decapping rods and pins when dies are not in use.

ITEM NO. 67950 \$64.50



New!

Bullet Seating Micrometers

Now available for handgun and straight wall cartridges

See Page 16



Piloted Inside Chamfering Tool

See Page 40

New!



Imperial Lubricants – produced by Redding



Highly respected Imperial Lubricants complement the Redding product line and are now produced at the Redding facility.

Imperial Sizing Die Wax is the most recognized product of the line. Because of its superior performance and ease of application and cleanup, this product has been a favorite of knowledgeable reloaders for years. Redding is committed to maintaining the integrity of this product by producing it to the exact formulation that made it so popular.

Imperial Dry Neck Lube is the perfect lube for those who neck size. This product can be used inside and outside the case neck, reducing the drag on both the die and size button without concern about powder contamination.

Imperial Bio-Green Case Lube

A petroleum free, super duty case forming and resizing lubricant made from biodegradable plant materials. Will not stain your brass – easy water clean up. **Imperial Bio-Green has proven to be our best liquid formulation ever . . . and is now included in all kits.**



ITEM NO. 07300 \$10.75

Imperial Convenience-Pak with Application Media

A convenient way to purchase Imperial Application Media (Item No. 07900) together with Imperial Dry Neck Lube for replenishment (Item No.07700) in one handy container.



ITEM NO. 07200 \$24.00



Imperial Dry Neck Lube

For use inside and outside the case neck to reduce drag on both the die and size button without concern of powder contamination. Packaged in 1 oz. container.

ITEM NO. 07700 \$11.25

Imperial Sizing Die Wax

“The original” - a favorite among discriminating reloaders. Packaged in 1 oz. & 2 oz. tins.

ITEM NO. 07500 (1 oz. tin) . . . \$10.25

ITEM NO. 07600 (2 oz. tin) . . . \$13.95



Imperial Application Media

The easy way to apply dry neck lube to case necks. Simply dip the cartridge case neck into the ceramic media. The media consists of high density ceramic spheres that are pre-charged with Imperial Dry Neck Lube. Can be used with all cartridge cases including 17 cal.

ITEM NO. 07900 \$13.95



Competition Bullet Seating Die

for Handgun & Straight Wall Rifle Cartridges

Patented System of Bullet Alignment

This die features a very unique way to bias the bullet into alignment with the cartridge case.

The precision fitting, spring loaded seating stem is allowed to move down into the chamber of the die, aligning the bullet and cartridge case well in advance of bullet seating.

Precise alignment is then maintained as the bullet and cartridge case move upward until seating is accomplished.

This *Patented System* assures you of the best possible bullet alignment.

Micrometer Adjustment

The micrometer is calibrated in .001" increments to simplify setting and recording bullet seating depth. Switching bullets and experimentation has never been easier.

Separate Crimp

Competition shooters know that superior reloads are produced when bullet crimping is performed as a separate operation. Therefore this no compromise die has no crimping capability. A superior crimp will be accomplished by using our "Profile Crimp" or "Taper Crimp" die.

Progressive Press Compatible

The industry standard 7/8 -14 threaded die bodies have been slightly extended to allow full thread engagement of the lock ring. An oversize bellmouth chamfer with smooth radius has been added to the bottom of the die to ease case and bullet entry in progressive presses.

See chart for cartridge availability **\$136.95**

**The Most Advanced
Bullet Alignment
Available**



U.S. Patent No. 6,244,154

Handgun Cartridges

Cartridge	Item No.
9MM Luger	55172
38 Super Auto	55271
38 Special/357 Magnum	55282
357 SIG	55434
40 S&W/10MM Auto	55253
41 Magnum	55185
44 Special/44 Magnum	55286
45 ACP & (45 GAP)	55189
45 Colt/454 Casull	55191
460 S&W Magnum	55278
500 S&W Magnum	55291

Straight Wall Rifle Cartridges

Cartridge	Item No.
38-40 Winchester	55366
38-55 Winchester	55365
40-65 Winchester	55465
44-40 Winchester	55188
45-70 Government	55209

Micrometer Adjustable Crimping Dies

Top adjusting for progressive presses with tight space constraints

Redding's new Micrometer Adjustable Crimping Dies are **top adjusting** to simplify making precise adjustments because any variation in case length and wall thickness both adversely affect proper adjustment.



Traditional Taper Crimp Die adjustment is both time consuming and imprecise due to the coarse 7/8 - 14 pitch die threads and the need to re-position the lock ring, this is especially important to users of progressive reloading presses with tight space constraints.

The new Micrometer Adjustable Crimping Dies have a knurled micrometer barrel situated on the top of the die for easy access and provides approximately $\pm .100$ " of "on-the-fly" adjustment in .001" increments.

Versatility is enhanced on handgun dies by being able to reverse the internal crimping sleeve to accommodate two different cartridges having closely related body diameters. An example is the 38 Super and the 9mm family of cartridges. *Rifle cartridges are non-reversible.*

See chart for cartridge availability **\$99.65**

Cartridge	Type	Item No.
223 Remington (Non-Reversible)	Taper Crimp	31111
308 Winchester (Non-Reversible)	Taper Crimp	31155
38 Special / 357 Magnum	Profile Crimp	31282
44 Special / 44 Magnum	Profile Crimp	31286
38 Super / 9mm	Taper Crimp	31271
40 S&W / 10mm Auto	Taper Crimp	31253
45 ACP / 45 GAP	Taper Crimp	31189

Dual Ring Carbide Sizing Die Sets

The correct answer for sizing straight wall handgun cartridges.

Dual Ring Carbide Sizing Dies are the correct answer to the compromise that has plagued traditional carbide dies of all manufacturers since their creation.

The traditional sizing ring is required to perform double duty *which it can not do*. It is required to size the case sufficiently to secure the bullet (with even the thinnest brass) which all do with some success. From that point however, all traditional carbide dies resize the remainder of your cases excessively.

The price of this compromise is shortened case life of your overworked brass, unsightly appearance and less than ideal chamber fit which may lead to an adverse effect on accuracy.

The Redding solution is unique, incorporating two carbide rings within one sizing die. The upper ring is positioned to size only the bullet retention portion of the cartridge case while the other is configured to properly size the case body without overworking the brass. Your sized cases will not only look good and function better but brass life will increase.

Since customers have been asking for Dual Ring Dies in complete sets, we are now packaging them in the same three configurations as our traditional die sets, as well as individually.

See chart below for availability.

Dual Ring Carbide Die Set	\$203.50
Dual Ring Pro-Series Die Set	\$222.90
Dual Ring Competition Pro-Series Die Set	\$315.25
Dual Ring Carbide Sizing Die only	\$163.25

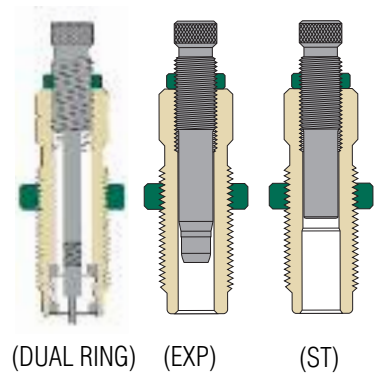

Dual Ring Carbide Die Set

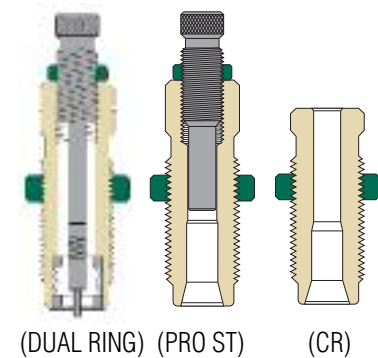

Dual Ring Pro-Series Die Set

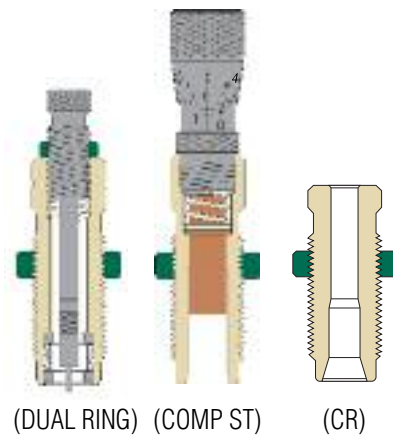

Dual Ring Competition Pro-Series Die Set

- Tech Talk - The Dual Ring Advantage

The first and most important task of traditional single ring carbide dies (of all Manufacturers) is to resize the cartridge case sufficiently to secure the bullet. Unfortunately the SAAMI specifications that control the cartridge case wall thickness have a -.006" tolerance. This requires the carbide sizing ring diameter to be designed relatively small, small enough to sufficiently resize the thinnest possible brass. This diameter then resizes the remainder of the case excessively.

It becomes obvious that the two areas of concern should be resized at different diameters. This compromise has been tolerated for years by handloaders for the sake of convenience, the convenience of not lubricating cases.

Our accuracy tests involving the 44 magnum @ 200 meters for Handgun Silhouette had long ago proven that our properly dimensioned steel sizing dies would always outperform traditional single ring carbide dies in the accuracy department with much better case life.

Our new Dual Ring Carbide Dies are able to replicate the advantages of our steel dies without the need for lubrication.

Cartridge	Dual Ring Carbide Sizer Die	Dual Ring Carbide Die Set	Dual Ring Pro-Series Die Set	Dual Ring Competition Pro-Series Die Set
38 Special	95183	01183	02183	06183
357 Magnum	95182	01182	02182	06182
40 Smith & Wesson	95272	01272	02272	06272
44 Special	95187	01187	02187	06187
44 Magnum	95186	01186	02186	06186
45 ACP	95189	01189	02189	06189
45 Colt	95191	01191	02191	06191

Titanium Carbide Die Sets

Titanium carbide differs considerably from other carbides, and is the ideal material for resizing cartridge cases. Titanium carbide has the highest hardness of any readily available carbide. The difference is in the microstructure. Viewed under a microscope it appears smooth and rounded, which presents a slippery non-galling surface, ideal for lubeless resizing of cartridges.

Two types of die sets are available. The conventional three (3) die set includes the titanium carbide sizing die, expander die and bullet seating die with built-in crimp.

The "Pro (progressive) Series Die Set" is a special three (3) die set designed for use in progressive machines. An expander die is not included in these sets as the most popular progressive machines expand the case mouth at the powder drop station.

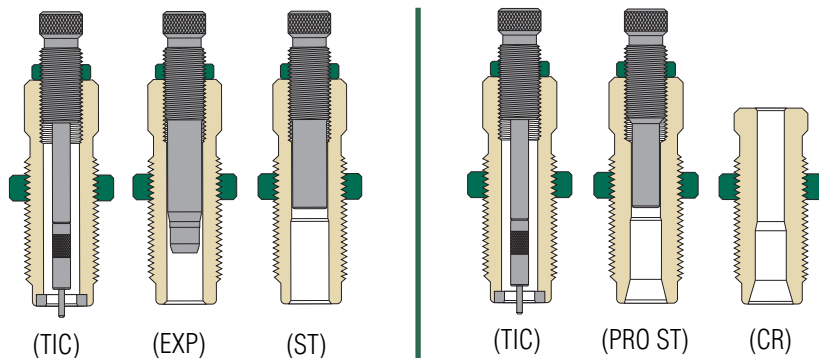

Conventional TIC Die Set . . \$144.85
9MM Luger / 500 S&W . . . \$169.25

Pro Series Die Set \$164.25
9MM Luger / 500 S&W . . . \$188.55

TIC Sizer Die only . . . \$104.50 — 9MM Luger / 500 S&W . . . \$127.85

Progressive die sets are supplied with a profile crimp die (or taper crimp die if the cartridge headspaces on the case mouth) because the best possible crimp is attained after the bullet is seated.

All Pro Series Die Sets are designed with a special large radius at the mouth of the seating and crimping dies for easy case entry.

Cartridge	Titanium Carbide Die Set	Titanium Carbide Sizer Die	Pro-Series Die Set	Pro-Series Seat Die	Taper Crimp Die	Profile Crimp Die	Extended Shellholder	Trim Die
32 ACP	88220	87220	89220	94220	85220	N.A.	22E	N.A.
32 Smith & Wesson Long	88158	87162	N.A.	N.A.	85158	86158	10E	83158
32 H & R Magnum	88261	87162	89261	N.A.	N.A.	86261	10E	83161
32 S & W Long/32 H & R Mag	88162	87162	89162	94162	85162	86162	10E	N.A.
380 Auto	88170	87170	89170	94170	85170	N.A.	10E	83170
9MM Luger	88172	87172	89172	94172	85172	N.A.	13E	83172
38 Special	88183	87282	N.A.	N.A.	N.A.	N.A.	12E	83183
357 Magnum	88182	87282	N.A.	N.A.	N.A.	86182	12E	83182
38 Spec/357 Mag	88282	87282	89282	94282	85282	86282	12E	N.A.
38 Super Auto	88271	87271	89271	94271	85271	N.A.	5E	83271
40 Smith & Wesson	88272	87253	89272	94272	85272	N.A.	5E	83272
10MM Auto	88520	87253	89520	94520	85520	N.A.	5E	83520
40 S&W/10MM Auto	88253	87253	89253	94253	85253	N.A.	5E	N.A.
41 Magnum	88185	87185	89185	94185	85185	86185	21E	83185
44 Special	88187	87286	N.A.	N.A.	N.A.	N.A.	19E	83187
44 Magnum	88186	87286	N.A.	N.A.	N.A.	86186	19E	83186
44 Spec/44 Mag	88286	87286	89286	94286	85286	86286	19E	N.A.
45 GAP	88305	87189	89305	94189	85305	N.A.	1E	N.A.
45 ACP	88189	87189	89189	94189	85189	N.A.	1E	83189
45 Auto Rim	88189	87189	89190	94189	85189	86189	17E	83189
45 Colt/454 Casull	88191	87191	89191	94191	85191	86191	23E	83191
460 S&W Magnum	88278	87191	89278	94278	N.A.	86278	23E	N.A.
500 S&W Magnum	88291	87291	89291	94291	N.A.	86291	N.A.	N.A.



Original G-Rx - Push-Thru Base Sizing Dies

The G-Rx push thru Base Sizing Die is designed to restore fired cases from 40 S&W autoloading pistols that exhibit a bulge near the base.

By passing the case completely through the new G-Rx Die, the bulge is removed and the case may be returned to service.

The new **G-Rx Carbide** accomplishes the same task without the need for lubrication.

- Item No. 96150** G-Rx Carbide Sizing Die * **\$124.45**
- Item No. 96040** G-Rx Steel Sizing Die * **62.25**
- Item No. 96010** Optional Bottle Adapter **15.60**
- Item No. 96020** Large 32 oz. HDPE Bottle **10.25**

*Includes Shellholder Pushrod



Optional Bottle adapter fits std. Powder & Shot bottles with 28-410 thread.

Competition Pro Series Die Sets

With Competition Bullet Seating Die

“Competition Pro (progressive) Series” three (3) die sets are designed for use in progressive reloading machines by reloaders seeking the best possible bullet alignment.

All progressive die sets are supplied with a profile crimp die (or taper crimp die if the cartridge headspaces on the case mouth) because the best possible crimp is attained

after the bullet is seated with the included Competition Bullet Seating Die

An expander die is not included in these sets as the most popular progressive machines expand the case mouth at the powder drop station.

All Pro Series Die Sets are designed with a special large radius at the mouth of the seating and crimping dies for easy case entry.

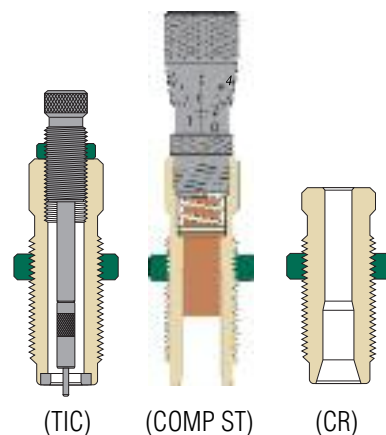

Carbide – Competition Pro Series Die Sets \$256.45 9MM Luger and 500 S&W \$280.80

Cartridge	Competition Pro-Series Die Set	Titanium Carbide Sizing Die	Competition Seating Die	Taper Crimp Die	Profile Crimp Die	Trim Die
9MM Luger	58172	87172	55172	85172	N.A.	83172
38 Special/357 Magnum	58282	87282	55282	—	86282	N.A.
38 Super Auto	58271	87271	55271	85271	N.A.	83271
40 S&W/10MM Auto	58253	87253	55253	85253	N.A.	N.A.
41 Magnum	58185	87185	55185	—	86185	83185
44 Special/44 Magnum	58286	87286	55286	—	86286	N.A.
45 GAP	58305	87189	55189	85305	N.A.	N.A.
45 ACP	58189	87189	55189	85189	N.A.	83189
45 Auto Rim	58190	87189	55189	—	86189	83189
45 Colt/454 Casull	58191	87191	55191	—	86191	83191
460 S&W Magnum	58278	87191	55278	N.A.	86278	N.A.
500 S&W Magnum	58291	87291	55291	N.A.	86291	N.A.

Non Carbide – Competition Pro Series Die Sets

With Competition Bullet Seating Die

Since carbide sizing dies are not available for certain cartridges, the Competition Pro Series Die Sets are also available with steel sizing dies.
(See chart below for availability).

Non Carbide – Competition Pro Series Die Sets . . . \$221.85

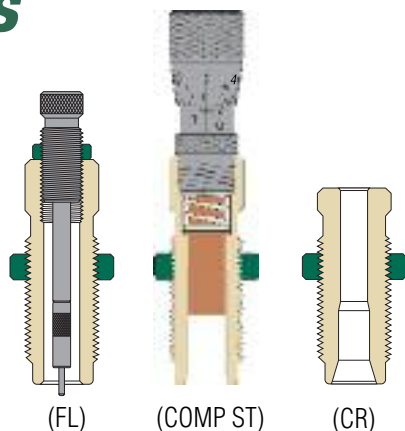

Cartridge	Competition Pro Series Die Set	Competition Seating Die	Sizing Die	Profile Crimp Die
38-40 Winchester	58366	55366	91366	86366
38-55 Winchester	58365	55365	91365	86365
40-65 Winchester	58465	55465	91465	86465
44-40 Winchester	58188	55188	91188	86188
45-70 Government	58209	55209	91209	86209

– Tech Talk – Frequently asked

Q: Why are carbide sizing dies not made for certain bottleneck and/or tapered cartridges?

A. While it is possible to produce carbide dies for tapered cartridges, the cost would be nearly prohibitive. Due to the tapered contact surfaces between the die and cartridge case, lubrication is still required. Thus, the advantage of carbide is lost. Any advantage in die life is negated by the increased cost.

Now anyone with a standard reloading press can benefit from advanced benchrest techniques.

Type S – Bushing Style Dies

The amount of resizing provided by conventional reloading dies has always been dictated by the manufacturing tolerances (SAAMI specifications) of the brass cartridge case itself. Reloading die manufacturers have been forced to design the neck diameter of their dies small enough to accommodate the thinnest possible brass.

This may be as much as .008" - .010" smaller than the maximum cartridge dimensions typically shown in most reloading manuals.

Since the majority of cases that the reloader is likely to encounter in the field are thicker than the minimum specifications that the dies were designed for, case necks are often resized excessively.

It can be easily demonstrated that excessive resizing of the cartridge case quickly leads to stress distortion and concentricity problems.

The new Type S - Bushing Style Dies offer a simple solution to this age old problem.



The Type S - Bushing Style Dies, Competition Seating and Neck Sizing Dies, Body Dies and our New Competition Shellholders are all products of Benchrest and 1000 yard Competition.

Type S – Neck Bushing Die

The Type S - Bushing Style Neck Sizing Die provides reloaders with a simple means to precisely control case neck size and tension.

- Uses interchangeable sizing bushings available in .001" increments.
- The adjustable decapping rod allows positioning the bushing to resize only a portion of the neck length if desired.
- Concentricity is enhanced by the ability of the resizing bushing to self-center on the case neck.
- The decapping rod is supplied with a standard size button. This is especially useful for reloaders who are using commercial brass as is.
- A decapping pin retainer is also supplied with most Type S - Bushing Dies except 17 and 20 Cal. This enables neck sizing without the use of the size button for those who sort and/or turn case necks for uniformity.

All dies are supplied without bushings. For ordering numbers see pages 8 & 9

Category I	\$93.35
Category II	113.25
Category III	140.00

Carbide size button kits are also available for all Type S Dies. See page 15 for kit numbers by caliber.

Type S – Full Bushing Die

Full length resizing while maintaining exact control of the case neck is often desirable in one operation. The new Type S - Full Length Resizing/Bushing Die accomplishes this task with the precision you would expect from Redding.

- Uses the same interchangeable bushings (.001" increments) as those used in our bushing style neck sizing dies.
- The adjustable decapping rod allows you to adjust the bushing position, sizing only part of the neck length when desired.
- Concentricity is enhanced by the ability of the bushing to self-center on the neck of the cartridge case.
- All Type S (except 17 and 20 Cal.) dies are supplied with both the standard size button and a decapping pin retainer for the advantages and versatility described under our Type S - Bushing Style Neck Sizing Dies.

Note: By removing the bushing and all internal parts, the Type-S full bushing die may also be used as a body die.

All dies are supplied without bushings. For ordering numbers see pages 8 & 9

Category I	\$93.35
Category II	113.25
Category III	140.00

Note: For the ultimate shoulder bump control, use these dies with our new Competition Shellholders. See page 18 for details.

Competition Bushing Style - Neck Sizing Die

Similar in design concept to our Competition Seating Die, the cartridge case is completely supported and aligned with the sizing bushing before the sizing process begins.

As the sizing process starts, the cartridge case remains supported in the tightly chambered, sliding sleeve as it moves upward while the resizing bushing self-centers on the case neck.

The decapping rod is maintained in precise alignment by using the internal parts of the die as a linear support much like that of a firing pin.

Meanwhile, the micrometer adjustment of the bushing position delivers precise control to the desired amount of neck length to be sized.

This die was designed for use by Competition Shooters who have meticulously prepared their cartridge cases and do not wish to use a sizing button, however, carbide size button kits are available separately. Refer to pages 4 & 5 for kit numbers by caliber.

All dies are supplied without bushings. For ordering numbers, see pages 8 & 9

- Category I \$179.85
- Category II 214.50
- Category III 266.25

Neck Sizing Bushings

Redding Neck Sizing Bushings are available in two styles. Both share the same external dimensions (1/2" O.D. x 3/8" long) and freely interchange in all Redding Bushing Style Sizing Dies.

They are available in .001" size increments throughout the range of .185" thru .368", covering all calibers from .17 to .338 and clearly marked with size I.D.

By selecting the correct bushing, you are now able to provide just the right amount of neck tension to properly hold the bullet without excessive resizing.

Item No. 73185 thru 73368 (specify size) \$24.00
Heat treated steel. The sizing diameters are hand-polished with a surface hardness of Rc 60-62 to reduce sizing effort.

Item No. 76185 thru 76368 (specify size) \$40.80
 Heat treated steel as above with the addition of a *Titanium Nitride* surface treatment to further increase the effective surface hardness and reduce sizing friction.

Item No. 76999 \$5.25
 Handy bushing storage box is available separately.

Body Dies

Redding has been making Body Dies for Benchrest Shooters for years, but they were never a catalogued item.

Now, with the introduction of the Bushing-Style Neck Sizing Dies, they are available as a companion item for most cartridges.

Body Dies are designed to full length resize the case body and bump the shoulder position for proper chambering without disturbing the case neck. They are made without internal parts and intended for use only to resize cases which have become increasingly difficult to chamber after repeated firing and neck sizing.

- Category I \$47.70
 - Category II 58.80
 - Category III 72.25
- For ordering numbers, see pages 8 & 9

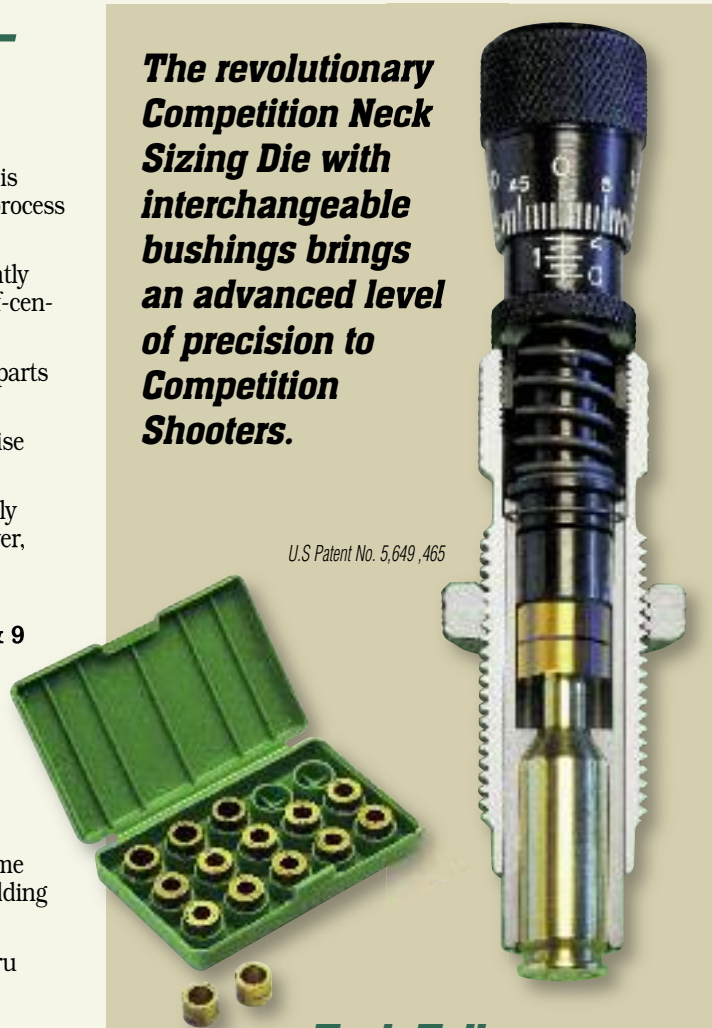

The revolutionary Competition Neck Sizing Die with interchangeable bushings brings an advanced level of precision to Competition Shooters.

U.S Patent No. 5,649,465

— Tech Talk —

Bushing Selection and Use

The easiest way to determine the proper diameter bushing, is to measure the neck diameter of several loaded or dummy cartridges with an accurate micrometer. Subtract .001"-.002" from the average neck diameter and this diameter bushing will generally size case necks to create the proper press fit for the bullet.

Another method is to measure the neck thickness with a ball micrometer or our Case Neck Gauge (see page 33). Double the neck wall thickness and add this number to the bullet diameter. The result is the neck diameter of a loaded cartridge, and bushing size can be determined as above.

After loading several cases, it's a good idea to test the neck's grip on the bullet. The simplest method is to push the bullet in a loaded cartridge against the edge of your reloading bench with moderate hand pressure. The bullet should not move easily in the case neck. If the bullet pushes deeper in the case, select the next smaller bushing and start again.

When using your bushing die, we have found that lubricating case necks and installing the bushing numbers down may improve results. Many experienced reloaders like to adjust the die to size 1/2 to 3/4 of the case neck. This has been shown to improve accuracy in most instances.

Final note: If you are not sorting case neck wall thickness for uniformity, we do not recommend the use of any bushing style die without a sizing button.

Note: For the ultimate shoulder bump control, use these dies with our new Competition Shellholders. See page 18 for details.

Competition Bullet Seating Die

“No seating die on the market is built to this level of precision.”

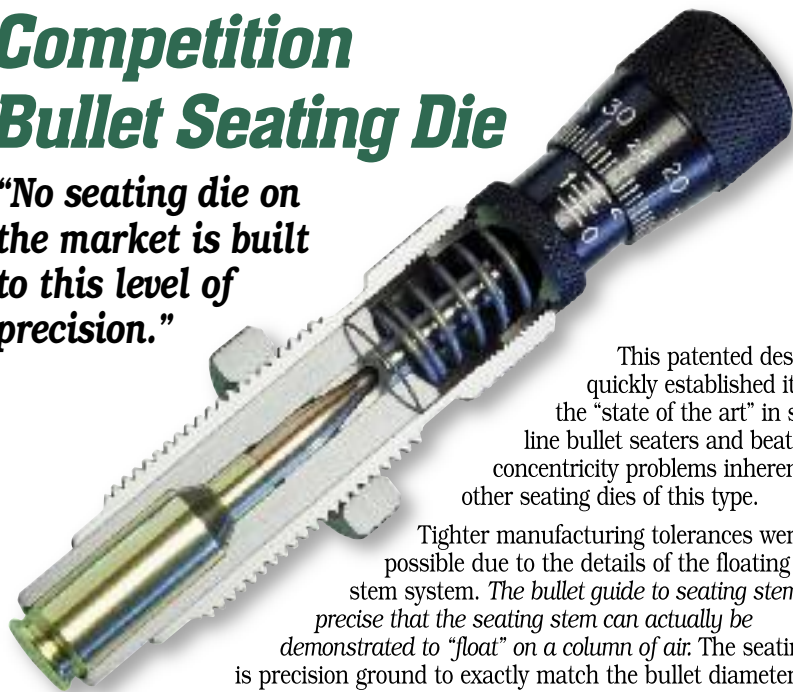

This patented design quickly established itself as the “state of the art” in straight line bullet seaters and beat the concentricity problems inherent in all other seating dies of this type.

Tighter manufacturing tolerances were made possible due to the details of the floating seating stem system. *The bullet guide to seating stem fit is so precise that the seating stem can actually be demonstrated to “float” on a column of air.* The seating stem is precision ground to exactly match the bullet diameter.

Alignment and accuracy are enhanced by the cartridge case and bullet being completely supported and aligned in a close fitting, precision ground sleeve before the bullet seating begins. The micrometer is calibrated in .001" increments for precise seating depth and is infinitely adjustable. The micrometer also has a feature that allows you to re-set it to your favorite seating depth. No seating die on the market is built to this level of precision.

For ordering numbers see chart below.

Category I \$179.85

Category II 214.50

Category III 266.25

See website for Accessory VLD style bullet seating stems.

“The Redding Competition Seaters are without question the finest bullet seaters I have ever used! The quality of construction and design is a ‘steal’! I am extremely impressed.”
- Fred Sinclair, Sinclair International

Bushing Style Dies

Cartridge	Type S – Bushing Full Die \$93.35	Type S – Bushing Neck Die \$93.35	Type S – Bushing Neck Die Set \$175.25	Type S – Match Bushing Full Die Set \$260.25	Type S – Match Bushing Neck Die Set \$304.80	Body Die \$47.70	Competition Bushing Neck Die \$179.85	Competition Seating Die \$179.85	Competition Bushing Neck Die Set \$386.55	Carbide Kit For Competition Bushing Die \$56.75
CATEGORY I										
204 Ruger	77287	71287	78287	36287	38287	75287	56287	55287	58287	97203
222 Remington	77109	71109	78109	36109	38109	75109	56109	55109	58109	98123
223 Remington	77111	71111	78111	36111	38111	75111	56111	55111	58111	98123
22 Nosler	77768	71768	78768	36768	38768	75768	56768	55768	58768	98123
22-250 Remington	77106	71106	78106	36106	38106	75106	56106	55106	58106	98123
220 Swift	77107	71107	78107	36107	38107	75107	56107	55107	58107	98223
6MM P.P.C. USA	77319	71319	78319	36319	38319	75319	56319	55319	58319	98024
6MM B.R. Rem (Norma BR)	77317	71317	78317	36317	38317	75317	56317	55317	58317	98024
243 Winchester	77114	71114	78114	36114	38114	75114	56114	55114	58114	98224
6MM Remington	77115	71115	78115	36115	38115	75115	56115	55115	58115	98224
25-06 Remington	77120	71120	78120	36120	38120	75120	56120	55120	58120	98325
260 Remington	77531	71531	78531	36531	38531	75531	56531	55531	58531	98226
6.5MM Creedmoor	77446	71446	78446	36446	38446	75446	56446	55446	58446	98226
6.5 x 55 Swedish	77132	71132	78132	36132	38132	75132	56132	55132	58132	98226
6.5MM/284 Win (Norma)	77415	71415	78415	36415	38415	75415	56415	55415	58415	98226
26 Nosler	77261	71261	78261	36261	38261	75261	56261	55261	58261	98326
270 Winchester	77135	71135	78135	36135	38135	75135	56135	55135	58135	99427
7MM-08 Remington	77139	71139	78139	36139	38139	75139	56139	55139	58139	99383
280 Ackley Improved	77428	71428	78428	36428	38428	75428	56428	55428	58428	99483
7MM Remington Mag	77136	71136	78136	36136	38136	75136	56136	55136	58136	99483
7MM Rem SA UM	77280	71280	78280	36280	38280	75280	56280	55280	58280	99383
28 Nosler	77790	71790	78790	36790	38790	75790	56790	55790	58790	99483
308 Winchester	77155	71155	78155	36155	38155	75155	56155	55155	58155	99307
30-06 Springfield	77148	71148	78148	36148	38148	75148	56148	55148	58148	99407
300 Winchester Mag	77153	71153	78153	36153	38153	75153	56153	55153	58153	99407
30 Nosler	77817	71817	78817	36817	38817	75817	56817	55817	58817	99407
300 Weatherby Mag	77252	71252	78252	36252	38252	75252	56252	55252	58252	99507
300 Rem Ultra Mag	77288	71288	78288	36288	38288	75288	56288	55288	58288	99507
300 WSM	77223	71223	78223	36223	38223	75223	56223	55223	58223	99307
CATEGORY II	\$113.25	\$113.25	\$219.60	\$314.70	\$369.25	\$58.80	\$214.50	\$214.50	\$463.25	\$56.75
17 Hornet	77279	71279	78279	36279	38279	75279	N.A.	55279	N.A.	N.A.
17 Remington Fireball	77204	71204	78204	36204	38204	75204	N.A.	55204	N.A.	N.A.
17 MACH IV	77504	71504	78504	36504	38504	75504	N.A.	55504	N.A.	N.A.
17 Remington	77217	71217	78217	36217	38217	75217	N.A.	55217	N.A.	N.A.
22 Hornet	77102	71102	78102	36102	38102	75102	N.A.	55102	N.A.	N.A.
221 Remington Fireball	77101	71101	78101	36101	38101	75101	56101	55101	58101	98023
223 Remington Imp 40°	77907	71907	78907	36907	38907	75907	56907	55907	58907	98123
22 P.P.C. USA	77318	71318	78318	36318	38318	75318	56318	55318	58318	98023
22 B.R. Remington	77316	71316	78316	36316	38316	75316	56316	55316	58316	98023
22-250 Rem Imp 40°	77406	71406	78406	36406	38406	75406	56406	55406	58406	98123
* 6 x 47 Lapua	77489	71489	N.A.	36489	38489	75489	N.A.	55489	N.A.	N.A.
243 Win Imp 40°	77420	71420	78420	36420	38420	75420	56420	55420	58420	98224
6MM Creedmoor	77443	71443	78443	36443	38443	75443	56443	55443	58443	98224
6MM Rem Imp 40°	77421	71421	78421	36421	38421	75421	56421	55421	58421	98224
6MM/284 Winchester	77414	71414	78414	36414	38414	75414	56414	55414	58414	98224

* Full Length Dies also available for 6 x 47 Lapua, Part #91489

Bushing Style Die Sets

TYPE S - MATCH Bushing Full Die Set

CONTAINS -

- Type S - Bushing Full Sizing Die
- Competition Seating Die

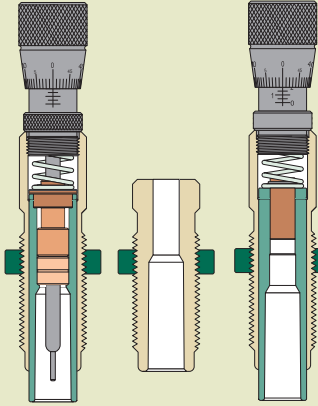

TYPE S - MATCH Bushing Neck Die Set

CONTAINS -

- Type S - Bushing Neck Sizing Die
- Body Die
- Competition Seating Die

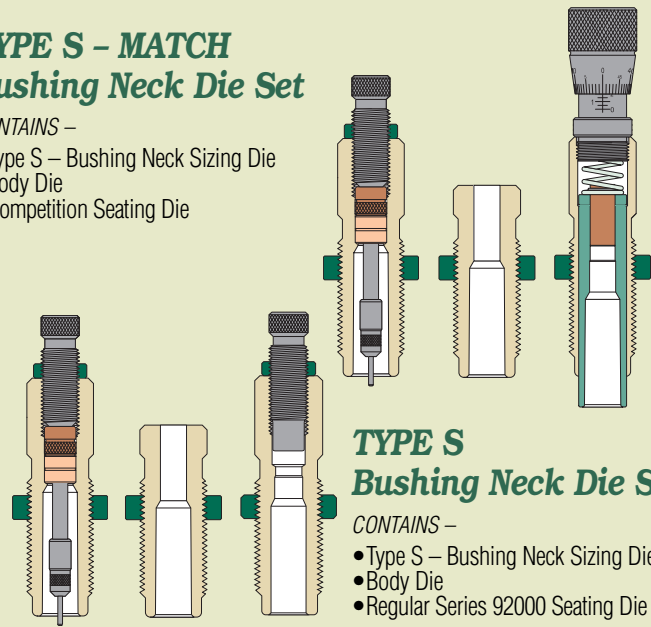

COMPETITION Bushing Neck Die Set

CONTAINS -

- Competition Bushing Neck Sizing Die
- Body Die
- Competition Seating Die

TYPE S Bushing Neck Die Set

CONTAINS -

- Type S - Bushing Neck Sizing Die
- Body Die
- Regular Series 92000 Seating Die

Bushing Style Dies *Continued*

Cartridge	Type S - Bushing Full Die CATEGORY II-Cont'd. \$113.25	Type S - Bushing Neck Die \$113.25	Type S - Bushing Neck Die Set \$219.60	Type S - Match Bushing Full Die Set \$314.70	Type S - Match Bushing Neck Die Set \$369.25	Body Die \$58.80	Competition Bushing Neck Die \$214.50	Competition Seating Die \$214.50	Competition Bushing Neck Die Set \$463.25	Carbide Kit For Competition Bushing Die \$56.75
<i>New!</i> 6.5 GRENDDEL™	77478	71478	78478	36478	38478	75478	56478	55478	58478	98226
<i>New!</i> 6.5 x 47 Lapua	77479	71479	78479	36479	38479	75479	56479	55479	58479	98226
6.8MM Rem SPC	77259	71259	78259	36259	38259	75259	56259	55259	58259	99127
270 WSM	77255	71255	78255	36255	38255	75255	56255	55255	58255	99327
280 Remington	77142	71142	78142	36142	38142	75142	56142	55142	58142	99483
7MM WSM	77265	71265	78265	36265	38265	75265	56265	55265	58265	99383
7MM STW	77544	71544	78544	36544	38544	75544	56544	55544	58544	99583
7MM Rem Ultra Mag	77923	71923	78923	36923	38923	75923	56923	55923	58923	99583
300 Blackout	N.A.	N.A.	N.A.	N.A.	N.A.	N.A.	N.A.	55327	N.A.	N.A.
300 Rem SA UM	77275	71275	78275	36275	38275	75275	56275	55275	58275	99307
<i>New!</i> 33 Nosler	77799	71799	78799	36799	38799	75799	56799	55799	58799	99433
338 Winchester Mag	77163	71163	78163	36163	38163	75163	56163	55163	58163	99433
338 Rem Ultra Mag	77874	71874	78874	36874	38874	75874	56874	55874	58874	99533
CATEGORY III	\$140.00	\$140.00	\$269.25	\$386.55	\$454.45	\$72.25	\$266.25	\$266.25	\$574.25	\$56.75
20 Vartarg	77636	71636	78636	36636	38636	75636	N.A.	55636	N.A.	N.A.
20 P.P.C.	77566	71566	78566	36566	38566	75566	N.A.	55566	N.A.	N.A.
20 B.R.	77666	71666	78666	36666	38666	75666	N.A.	55666	N.A.	N.A.
20 Tactical	77660	71660	78660	36660	38660	75660	56660	55660	58660	97203
223 WSSM	77295	71295	78295	36295	38295	75295	56295	55295	58295	98123
243 WSSM	77270	71270	78270	36270	38270	75270	56270	55270	58270	98124
6mmXC	77745	71745	78745	36745	38745	75745	N.A.	55745	N.A.	98224
6MM/22-250	77516	71516	78516	36516	38516	75516	56516	55516	58516	98224
250 Savage	77122	71122	78122	36122	38122	75122	56122	55122	58122	98125
257 Roberts	77125	71125	78125	36125	38125	75125	56125	55125	58125	98225
257 Roberts Imp 40°	77322	71322	78322	36322	38322	75322	56322	55322	58322	98225
25 WSSM	77263	71263	78263	36263	38263	75263	56263	55263	58263	98125
25-06 Rem Imp 40°	77422	71422	78422	36422	38422	75422	56422	55422	58422	98325
257 Weatherby Mag	77226	71226	78226	36226	38226	75226	56226	55226	58226	98325
260 Remington Imp 40°	77623	71623	78623	36623	38623	75623	56623	55623	58623	98226
6.5MM/06 A-Square	77378	71378	78378	36378	38378	75378	N.A.	55378	N.A.	N.A.
264 Winchester Mag	77127	71127	78127	36127	38127	75127	56127	55127	58127	98326
7MM TCU	77242	71242	78242	36242	38242	75242	56242	55242	58242	99283
7MM B. R. Remington	77241	71241	78241	36241	38241	75241	56241	55241	58241	99183
7MM X 57 Mauser	77138	71138	78138	36138	38138	75138	N.A.	55138	N.A.	N.A.
284 Winchester	77141	71141	78141	36141	38141	75141	56141	55141	58141	99383
7MM Weatherby Mag	77237	71237	78237	N.A.	N.A.	75237	N.A.	N.A.	N.A.	N.A.
30 B.R.	77524	71524	78524	36524	38524	75524	N.A.	55524	N.A.	99607
30-30 Winchester	N.A.	71146	78146	N.A.	N.A.	75146	N.A.	N.A.	N.A.	N.A.
303 British	77154	71154	78154	N.A.	N.A.	75154	N.A.	N.A.	N.A.	N.A.
30/338 Winchester Mag	77394	71394	78394	36394	38394	75394	56394	55394	58394	99407
30-378 Weatherby Mag	77547	71547	78547	N.A.	N.A.	75547	N.A.	N.A.	N.A.	N.A.
<i>New!</i> 300 Norma Mag	77928	71928	78928	36928	38928	75928	N.A.	55928	N.A.	N.A.
338 Lapua Mag	77594	71594	78594	36594	38594	75594	56594	55594	58594	99533

Rifle & Handgun Die Sets

The quality and accuracy of your reloaded ammunition depends largely on the quality of the equipment you use to assemble it.



Your choice of reloading dies should not be a casual one. Your dies literally shape the quality and function of your reloads. Because they are so important, we give them a lot of attention.

- We use the finest alloy steels obtainable.
- Our dies are machined on Hardinge Super-Precision® lathes capable of holding the tightest tolerances in the industry.
- We guarantee our dies to produce ammunition that will properly fit any standard (SAAMI) chamber, regardless of action type.
- To maintain tolerances and guarantee that your dies will last a lifetime, they are heat treated in atmospherically controlled furnaces.
- All dies are hand polished for smooth, flawless functioning, inspected, and are ultrasonically cleaned before packaging.
- The die box is a handy cartridge loading block and storage package. Inside is a spare decapping pin, hex wrench, and a place for your shellholder!
- All Redding dies use the industry standard 7/8-14 threaded bodies.

On the following pages you will find many products that are uniquely Redding. Most have evolved by listening to the needs and desires of our customers and helping them solve specific problems.

The design of our Profile Crimp Die is an example that came about from an attempt to help silhouette shooters solve the typical “half moon” crimp so prevalent with magnum handgun cartridges. Our solution to the problem not only solved the ugly, half crimp, but proved to tighten groups as well.

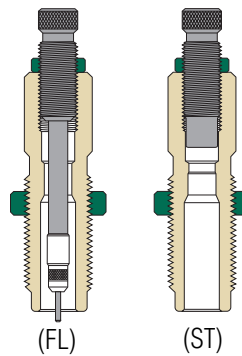

Full Length Die Sets For Bottleneck Cases

Full length die sets for bottleneck cases contain two dies. The full length (FL) resizing die contains a decapping rod assembly with a neck expander (size button). The seating die (ST) includes bullet guide, built-in crimp ring and the proper seating plug.

Neck Die Sets For Bottleneck Cases

Neck die sets for bottleneck cases contain two dies. The neck (NK) resizing die contains a decapping rod assembly with a neck expander (size button). The seating die (ST) includes bullet guide, built in crimp ring and the proper seating plug.

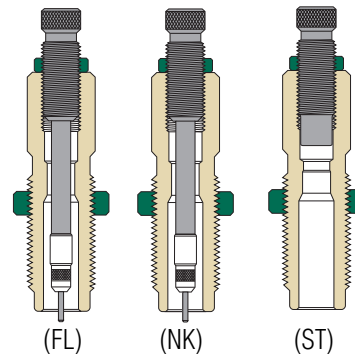
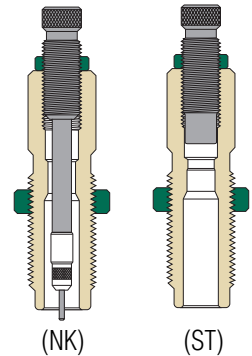

Deluxe Die Sets For Bottleneck Cases

Deluxe die sets for bottleneck cases contain three dies. They are a special packaging of our full length die sets (described above) with the addition of a neck (NK) sizing die.

Die Sets For Straight Wall Cases

Die sets for straight wall cases contain three dies. This is necessary because it is not possible to full length resize straight wall cases and expand the neck for proper bullet fit in one operation. The full length (FL) resizing die contains a decapping rod assembly. The expander die (EXP) contains a neck expanding plug. The seating die (ST) includes bullet guide, built-in crimp ring and the proper seating plug.

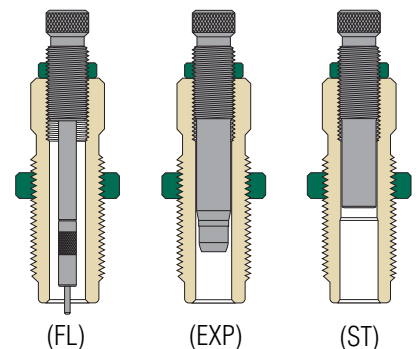

Seating Dies With Taper Crimp

Reloading dies for handgun calibers that headspace on the case mouth are indicated with a ♦. The seating dies in these calibers are made with a taper crimp. All other calibers have the standard roll crimp. Recent tests have shown that seating the bullet to its proper depth and crimping as a separate operation will produce the best accuracy. See page 15 for additional information on crimp dies.

SERIES A - Rifle & Handgun Dies

The Reloading die sets listed in this category represent the most popular dies that we produce. Although all Redding Dies are made to the same high quality standards, Series A is the lowest price, due to the efficiency of higher production **\$78.55**



SERIES A - Die Sets For Bottleneck Cases

Cartridge	Full Length Die Set	Deluxe Die Set	Neck Sizing Die	Neck Die Sets	Full Length Sizing Die	Decap Rod Assembly	Decap Rod	Size Button	Seating Die	Seat Plug	Form & Trim Die
	\$78.55	\$124.95	\$53.35	\$78.55	\$53.35	\$20.40	\$13.55	\$11.75	\$47.70	\$13.55	\$47.70
204 Ruger	80287	84287	81287	82287	91287	31203	01031	42203	92287	01085	83287
221 Remington Fireball	80101	84101	81101	82101	91101	32223	01032	42223	92101	01085	83101
22 Hornet	80102	84102	81102	82102	91102	32923	01032	39223	92102	01085	83102
220 Swift	80107	84107	81107	82107	91107	34223	01034	42223	92107	01083	83107
222 Remington	80109	84109	81109	82109	91109	32223	01032	42223	92109	01084	83109
22-250 Remington	80106	84106	81106	82106	91106	33223	01033	42223	92106	01083	83106
223 Remington	80111	84111	81111	82111	91111	33223	01033	42223	92111	01083	83111
243 Winchester	80114	84114	81114	82114	91114	33242	01033	42242	92114	01067	83114
6MM Remington	80115	84115	81115	82115	91115	34242	01034	42242	92115	01066	83115
25-06 Remington	80120	84120	81120	82120	91120	34256	01034	42256	92120	01067	83120
257 Roberts	80125	84125	81125	82125	91125	34256	01034	42256	92125	01066	83125
260 Remington	80531	84531	81531	82531	91531	33263	01033	42263	92531	01067	83531
6.5 Creedmoor	80446	84446	81446	82446	91446	33263	01033	42263	92446	01067	N.A.
6.5MM/284 Win (Norma)	80415	84415	81415	82415	91415	34263	01034	42263	92415	01067	83415
6.5 x 55 Swedish	80132	84132	81132	82132	91132	34263	01034	42263	92132	01066	83132
270 Winchester	80135	84135	81135	82135	91135	25276	01025	41276	92135	01066	83135
270 WSM	80255	84255	81255	82255	91255	23276	01023	41276	92255	01067	83255
7MM-08 Remington	80139	84139	81139	82139	91139	23283	01023	41283	92139	01067	83139
7MM Remington Mag	80136	84136	81136	82136	91136	24283	01024	41283	92136	01067	83136
7MM x 57 Mauser	80138	84138	81138	82138	91138	24283	01024	41283	92138	01067	83138
280 Ackley Improved	80428	84428	81428	82428	91428	25283	01025	41283	92428	01066	83428
30-30 Winchester	80146	84146	81146	82146	91146	23307	01023	41307	92146	01080	83146
30-06 Springfield	80148	84148	81148	82148	91148	24307	01024	41307	92148	01080	83148
300 Remington Ultra Mag	80288	84288	81288	82288	91288	25307	01025	41307	92288	01080	83288
300 WSM	80223	84223	81223	82223	91223	23307	01023	41307	92223	01080	83223
300 Winchester Mag	80153	84153	81153	82153	91153	25307	01025	41307	92153	01079	83153
300 Weatherby Mag	80252	84252	81252	82252	91252	25307	01025	41307	92252	01080	83252
308 Winchester/307 Winchester	80155	84155	81155	82155	91155	23307	01023	41307	92155	01080	83155
8MM x 57 Mauser	80159	84159	81159	82159	91159	24322	01024	41322	92159	01080	83159
338 Winchester Mag	80163	84163	81163	82163	91163	24336	01024	41336	92163	01063	83163
375 H & H Magnum	80169	84169	81169	82169	91169	25373	01025	41373	92169	01081	83169

SERIES A - Die Sets For Straight Wall Cases

Cartridge	Three Die Set	Sizing Die	Decap Rod Assembly	Seating Die	Seat Plug	Expander Die	Expander	Profile Crimp	Taper Crimp	Trim Die
	\$78.55	\$42.80	\$20.40	\$39.80	\$13.55	\$29.95	\$17.85	\$42.35	\$42.35	\$47.70
30 M1 Carbine ♦	80180	91180	22097	92180 ♦	01069	93180	95307	N.A.	85180	83180
32 Smith & Wesson Long	80158	91158	22097	92158	01073	93158	93310	86158	85158	83158
32 H & R Magnum	80161	91161	22097	92161	01069	93161	93310	86261	N.A.	83161
32 S & W Long/32 H & R Mag	80162	91162	22097	92162	01073	93162	93310	86162	85162	N.A.
9MM Luger ♦	80172	91172	22097	92172 ♦	01072	93172	91354	N.A.	85172	83172
38 Special	80183	91183	22097	92183	01071	93183	94356	N.A.	N.A.	83183
357 Magnum	80182	91182	22097	92182	01071	93182	94356	86182	N.A.	83182
38 Spec/357 Mag	80184	91184	22097	92184	01071	93184	94356	86282	85282	N.A.
40 Smith & Wesson ♦	80272	91272	22097	92272 ♦	01092	93272	92399	N.A.	85272	83272
10MM Auto ♦	80520	91520	22097	92520 ♦	01087	93520	93399	N.A.	85520	83520
40 S & W/10MM Auto ♦	80253	91253	22097	92253 ♦	01092	93253	92399	N.A.	85253	N.A.
44 Special	80187	91187	21097	92187	01074	93187	94428	N.A.	N.A.	83187
44 Magnum	80186	91186	21097	92186	01074	93186	94428	86186	N.A.	83186
44 Spec/44 Mag	80194	91194	21097	92194	01074	93194	94428	86286	85286	N.A.
44-40 Winchester	80188	91188	21097	92188	01074	93188	95426	86188	N.A.	N.A.
45 ACP/45 Auto Rim ♦	80189	91189	21097	92189 ♦	01075	93189	93450	86189+	85189	83189
45 Colt/454 Casull	80191	91191	21097	92191	01076	93191	95450	86191	85191	83191

♦ Denotes taper crimp seating die.

+Profile Crimp for 45 Auto Rim only



SERIES B - Rifle & Handgun Dies

Reloading dies in this Series are slightly less popular or are more costly to produce than our Series A die sets **\$106.60**

SERIES B - Die Sets For Bottleneck Cases

Cartridge	Full Length Die Set \$106.60	Deluxe Die Set \$171.30	Neck Sizing Die \$71.70	Neck Die Sets \$106.60	Full Length Sizing Die \$71.70	Decap Rod Assembly \$20.40	Decap Rod \$13.55	Size Button \$11.75	Seating Die \$64.55	Seat Plug \$13.55	Form & Trim Die \$64.55
17 Hornet	80279	84279	81279	82279	91279	26171	01026	37171	92279	01085	83279
17 Remington Fireball	80204	84204	81204	82204	91204	26171	01026	37171	92204	01085	N.A.
17 Remington	80217	84217	81217	82217	91217	31171	01031	42171	92217	01085	83217
218 Bee	80200	84200	81200	82200	91200	32923	01032	39223	92200	01085	83200
22 K-Hornet	80362	84362	81362	82362	91362	32923	01032	39223	92362	01085	83362
22 B.R. Remington	80316	84316	81316	82316	91316	32223	01032	42223	92316	01083	83316
22 P.P.C. USA	80318	84318	81318	82318	91318	32223	01032	42223	92318	01084	83318
<i>New!</i> 22 Nosler	80768	84768	81768	82768	91768	33223	01033	42223	92768	01083	N.A.
6MM B.R. Rem (Norma BR)	80317	84317	81317	82317	91317	32242	01032	42242	92317	01067	83317
6MM P.P.C. USA	80319	84319	81319	82319	91319	32842*	01032	19242*	92319	01067	83319
250 Savage (250-3000)	80122	84122	81122	82122	91122	33256	01033	42256	92122	01067	83122
256 Winchester Mag	80233	84233	81233	82233	91233	32956	01032	39256	92233	01066	83233
257 Weatherby Mag	80226	84226	81226	82226	91226	35256	01035	42256	92226	01066	83226
264 Winchester Mag	80127	84127	81127	82127	91127	34263	01034	42263	92127	01062	83127
<i>New!</i> 26 Nosler	80261	84261	81261	82261	91261	35263	01035	42263	92261	01066	83261
270 Weatherby Mag	80234	84234	81234	82234	91234	25276	01025	41276	92234	01066	83234
6.8MM Remington SPC	80259	84259	81259	82259	91259	22276	01022	41276	92259	01067	83259
7MM B.R. Remington	80241	84241	81241	82241	91241	22283	01022	41283	92241	01067	83241
7MM Rem SA UM	80280	84280	81280	82280	91280	23283	01023	41283	92280	01080	83280
7MM WSM	80265	84265	81265	82265	91265	23283	01023	41283	92265	01067	83265
7MM Remington Ultra Mag	80923	84923	81923	82923	91923	25283	01025	41283	92923	01067	83923
7MM STW (Shooting Times)	80544	84544	81544	82544	91544	25283	01025	41283	92544	01062	83544
<i>New!</i> 28 Nosler	80790	84790	81790	82790	91790	25283	01025	41283	92790	01067	83790
280 Remington (7MM Exp. Rem.)	80142	84142	81142	82142	91142	25283	01025	41283	92142	01066	83142
284 Winchester	80141	84141	81141	82141	91141	24283	01024	41283	92141	01066	83141
7.62MM x 39	80129	84129	81129	82129	91129	22307	01022	41307	92129	01067	83129
7.62MM Russian (7.62MM x 54R)	80290	N.A.	N.A.	N.A.	91290	23307	01023	41307	92290	01080	N.A.
<i>New!</i> 30 Nosler	80817	84817	81817	82817	91817	25307	01025	41307	92817	01080	83817
300 Blackout	80327	84327	81327	82327	91327	22307	01022	41307	92327	01079	83327
300 Savage	80151	84151	81151	82151	91151	23307	01023	41307	92151	01079	83151
300 H & H Magnum	80150	N.A.	N.A.	N.A.	91150	25307	01025	41307	92150	01080	83150
308 Norma Mag	80258	84258	81258	82258	91258	25307	01025	41307	92258	01079	83258
303 British	80154	84154	81154	82154	91154	24310	01024	41310	92154	01079	83154
325 WSM	80202	84202	81202	82202	91202	23822*	01023	16322*	92202	01080	N.A.
338 Federal	80264	84264	81264	82264	91264	23837*	01023	16336*	92264	01080	N.A.
338 Remington Ultra Mag	80874	84874	81874	82874	91874	25336	01025	41336	92874	01063	83874
<i>New!</i> 33 Nosler	80799	84799	81799	82799	91799	24336	01024	41336	92799	01063	N.A.
340 Weatherby Mag	80256	84256	81256	82256	91256	25336	01025	41336	92256	01063	N.A.
35 Remington	80165	84165	81165	82165	91165	23356	01023	41356	92165	01081	83165
35 Whelen	80215	84215	81215	82215	91215	24856*	01024	16356*	92215	01081	83215
350 Remington Mag	80266	84266	81266	82266	91266	24356	01024	41356	92266	01082	83266
358 Winchester/356 Winchester	80227	84227	81227	82227	91227	23856*	01023	16356*	92227	01081	83227
375 Ruger	80269	84269	81269	82269	91269	25373	01025	41373	92269	01082	N.A.
416 Ruger	80347	84347	81347	82347	91347	25414	01025	41414	92347	01081	N.A.
45-70 Govt.			81209	82209							

— SEE BELOW FOR OTHER 45-70 DIES —

SERIES B - Die Sets For Straight Wall Cases

Cartridge	Three Die Set \$106.60	Sizing Die \$57.85	Decap Rod Assembly \$20.40	Seating Die \$56.25	Seat Plug \$13.55	Expander Die \$39.80	Expander \$17.85	Profile Crimp \$51.30	Taper Crimp \$51.30	Trim Die \$64.55
32 ACP	80220	91220	22097	92220	01070	93220	90310	N.A.	85220	N.A.
32-20 Winchester	80281	91281	22097	92281	01069	93281	95311	86281	N.A.	83281
380 Auto ♦	80170	91170	22097	92170 ♦	01078	93170	91354	N.A.	85170	83170
38 Super Auto	80271	91271	22097	92271	01072	93271	93354	N.A.	85271	83271
41 Magnum	80185	91185	22097	92185	01077	93185	95409	86185	85185	83185
45-70 U.S. Govt.	80209	91209	27097	92209	01065	93209	99457	86209	N.A.	83209
458 Winchester Mag	80208	91208	28097	92208	01065	93208	99457	86208	N.A.	83208
460 S&W Magnum	80278	91278	27097	92278	01096	93278	95450	86278	N.A.	83278
500 S&W Magnum	80291	91291	21097	92291	01094	93291	96498	86291	N.A.	N.A.

*Denotes tapered size button. ♦ Denotes taper crimp seating die.

SERIES C - Rifle & Handgun Dies

Series C dies are less popular than the die sets listed in Series A & B.
This listing also contains many popular wildcats \$140.00



SERIES C - Die Sets For Bottleneck Cases

Cartridge	Full Length Die Set \$140.00	Deluxe Die Set \$221.25	Neck Sizing Die \$91.25	Neck Die Sets \$140.00	Full Length Sizing Die \$91.25	Decap Rod Assembly \$20.40	Decap Rod \$13.55	Size Button \$11.75	Seating Die \$80.55	Seat Plug \$13.55	Form & Trim Die \$80.55
20 Tactical	80660	84660	81660	82660	91660	31203	01031	42203	92660	01085	83660
219 Zipper	80360	N.A.	N.A.	N.A.	91360	33223	01033	42223	92360	01083	83360
222 Remington Mag	80203	84203	81203	82203	91203	33223	01033	42223	92203	01083	83203
223 WSSM	80295	84295	81295	82295	91295	32223	01032	42223	92295	01084	83295
225 Winchester	80239	84239	81239	82239	91239	33223	01033	42223	92239	01083	83239
22-250 Improved 40°	80406	84406	81406	82406	91406	33223	01033	42223	92406	01083	83406
6MM TCU	80245	84245	81245	82245	91245	33842*	01033	19242*	92245	01066	83245
6MM Creedmoor	80443	84443	81443	82443	91443	33242	01033	42242	92443	01067	N.A.
6MM/223 Rem (6MM x 45)	80312	84312	81312	82312	91312	33842*	01033	19242*	92312	01066	83312
6MM/284 Winchester	80414	84414	81414	82414	91414	34242	01034	42242	92414	01066	83414
240 Weatherby Mag	80232	84232	81232	82232	91232	34242	01034	42242	92232	01067	83232
243 Winchester Improved 40°	80420	84420	81420	82420	91420	33242	01033	42242	92420	01067	83420
243 WSSM	80270	84270	81270	82270	91270	32242	01032	42242	92270	01067	83270
25-20 Winchester	80218	84218	81218	82218	91218	32956	01032	39256	92218	01066	83218
25 WSSM	80263	84263	81263	82263	91263	32256	01032	42256	92263	01067	83263
257 Roberts Improved 40°	80322	84322	81322	82322	91322	34256	01034	42256	92322	01066	83322
6.5 GRENDDEL™	80478	84478	81478	82478	91478	32263	01032	42263	92478	01067	N.A.
6.5 X 47 Lapua	80479	84479	81479	82479	91479	33263	01033	42263	92479	01067	N.A.
6.5-06 (A-SQUARE)	80378	84378	81378	82378	91378	34263	01034	42263	92378	01067	83378
7-30 Waters	80230	84230	81230	82230	91230	23283	01023	41283	92230	01067	83230
7MM x 64 Brenneke	80340	84340	81340	82340	91340	24283	01024	41283	92340	01062	83340
7MM Weatherby Mag	80237	84237	81237	82237	91237	25283	01025	41283	92237	01067	83237
7.5 x 55 Swiss (K-31)	80235	84235	81235	82235	91235	24307	01024	41307	92235	01079	83235
30-06 Improved 40°	80324	84324	81324	82324	91324	24307	01024	41307	92324	01080	83324
30-40 Krag	80147	84147	81147	82147	91147	24307	01024	41307	92147	01080	83147
30/338 Winchester Mag	80394	84394	81394	82394	91394	24307	01024	41307	92394	01063	83394
30-378 Weatherby Mag	80547	84547	81547	82547	91547	25307	01025	41307	92547	01080	83547
303 Savage	80296	N.A.	N.A.	N.A.	91296	23307	01023	41307	92296	01080	N.A.
32-40 Winchester	80225	N.A.	N.A.	N.A.	91225	23320	01023	41320	92225	01080	N.A.
32 Remington	80332	N.A.	N.A.	N.A.	91332	23820*	01023	16320*	92332	01080	N.A.
32 Winchester Spec.	80157	84157	81157	82157	91157	23320	01023	41320	92157	01080	83157
338-06 (A-SQUARE)	80328	84328	81328	82328	91328	24837*	01024	16336*	92328	01063	83328
338 Lapua Mag	80594	84594	81594	82594	91594	25336	01025	41336	92594	01063	83594
348 Winchester	80336	N.A.	N.A.	N.A.	91336	24347	01024	41347	92336	01081	83336
35 Winchester	80335	N.A.	N.A.	N.A.	91335	24356	01024	41356	92335	01081	N.A.
358 Norma Mag	80210	N.A.	N.A.	N.A.	91210	24356	01024	41356	92210	01081	83210
9MM x 57 Mauser	80357	N.A.	N.A.	N.A.	91357	24356	01024	41356	92357	01081	83357
9.3MM x 62 Mauser	80345	84345	81345	82345	91345	24364	01024	41364	92345	01064	83345
416 Remington Magnum	80442	84442	81442	82442	91442	25414	01025	41414	92442	01064	83442
458 SOCOM	80444	N.A.	N.A.	N.A.	91444	21456	01021	41456	92444	01096	N.A.

SERIES C - Die Sets For Straight Wall Cases

Cartridge	Three Die Set \$140.00	Sizing Die \$70.25	Decap Rod Assembly \$20.40	Seating Die \$68.25	Seat Plug \$13.55	Expander Die \$48.90	Expander \$17.85	Profile Crimp \$64.55	Taper Crimp \$64.55	Trim Die \$80.55
30 Mauser (7.62 x 25 Tokarev)	80251	91251	22097	92251	01069	93251	93307	N.A.	N.A.	83251
357 SIG ♦	80434	91434	22097	92434 ♦	01072	93434	91354	N.A.	85434	83434
38-55 Winchester & Ballard	80365	91365	23097	92365	01081	93365	99374	86365	N.A.	83365
38-40 Winchester	80366	91366	22097	92366	01071	93366	95399	86366	N.A.	83366
375 Winchester	80206	91206	23097	92206	01081	93206	99374	N.A.	N.A.	N.A.
40-65 Winchester	80465	91465	23097	92465	01081	93465	94407	86465	N.A.	83465
41 Long Colt	80370	91370	22097	92370	01077	93370	94385	N.A.	N.A.	N.A.
444 Marlin	80207	91207	28097	92207	01068	93207	97428	N.A.	N.A.	83207
450 Marlin	80350	91350	27097	92350	01065	93350	99457	N.A.	N.A.	N.A.

* Denotes tapered size button. ♦ Denotes taper crimp seating die.



SERIES D - Rifle & Handgun Dies

Series D die sets represent obsolete cartridges, wildcats, etc., essentially custom stock. We attempt to maintain inventory in limited quantities. Consult us for your specific needs . . . **\$156.80**

SERIES D - Die Sets For Bottleneck Cases

Cartridge	Full Length Die Set \$156.80	Deluxe Die Set \$247.75	Neck Sizing Die \$102.95	Neck Die Sets \$156.80	Full Length Sizing Die \$102.95	Decap Rod Assembly \$20.40	Decap Rod \$13.55	Size Button \$11.75	Seating Die \$89.00	Seat Plug \$13.55	Form & Trim Die \$89.00
17 MACH IV	80504	84504	81504	82504	91504	26171	01026	37171	92504	01085	83504
219 Donaldson Wasp	80403	84403	81403	82403	91403	33223	01033	42223	92403	01083	83403
219 Don. Wasp Short (original)	80402	84402	81402	82402	91402	33223	01033	42223	92402	01083	83402
22 Savage H.P. (5.6MM x 52R)	80338	N.A.	N.A.	N.A.	91338	33227	01033	42227	92338	01084	83338
223 Remington Improved 40°	80907	84907	81907	82907	91907	33223	01033	42223	92907	01083	N.A.
224 Weatherby Mag	80212	84212	81212	82212	91212	33223	01033	42223	92212	01084	83212
5.7 x 28	80477	84477	81477	82477	91477	37923	01037	39223	92477	01085	N.A.
6MM Remington Improved 40°	80421	84421	81421	82421	91421	34242	01034	42242	92421	01066	83421
6MM XC	80745	84745	81745	82745	91745	33842*	01033	19242*	92745	01067	N.A.
25-35 Winchester	80221	84221	81221	82221	91221	33256	01033	42256	92221	01067	83221
25 Remington	80325	N.A.	N.A.	N.A.	91325	33256	01033	42256	92325	01067	83325
250 Savage Improved 40°	80416	84416	81416	82416	91416	33256	01033	42256	92416	01067	83416
25/284 Winchester	80417	84417	81417	82417	91417	34256	01034	42256	92417	01067	83417
25-06 Remington Improved 40°	80422	84422	81422	82422	91422	34256	01034	42256	92422	01067	N.A.
260 Remington Improved 40°	80623	84623	81623	82623	91623	33263	01033	42263	92623	01067	N.A.
6.5MM x 50 Japanese	80224	84224	81224	82224	91224	33263	01033	42263	92224	01067	83224
6.5MM x 54 Mannlicher	80277	84277	81277	82277	91277	33263	01033	42263	92277	01062	83277
6.5MM x 57 Mauser	80228	84228	81228	82228	91228	34263	01034	42263	92228	01067	83228
6.5MM Remington Mag	80231	84231	81231	82231	91231	34263	01034	42263	92231	01067	83231
6.5 - 300 Weatherby Mag	80379	84379	81379	82379	91379	35263	01035	42263	92379	01067	83379
7MM TCU	80242	84242	81242	82242	91242	23883*	01023	16283*	92242	01067	83242
7MM-08 Rem. Improved 40°	80430	84430	81430	82430	91430	23283	01023	41283	92430	01067	83430
7MM x 57 Improved 40°	80427	84427	81427	82427	91427	24283	01024	41283	92427	01067	83427
7MM/300 Weatherby Mag	80384	84384	81384	82384	91384	25283	01025	41283	92384	01067	83384
300/221 Remington	80432	84432	81432	82432	91432	22807*	01022	16307*	92432	01079	83432
30 Remington	80392	N.A.	N.A.	N.A.	91392	23307	01023	41307	92392	01080	N.A.
30 Remington AR	80214	84214	81214	82214	91214	22307	01022	41307	92214	01079	N.A.
300 RCM	80257	84257	81257	82257	91257	23307	01023	41307	92257	01080	N.A.
300 Rem SA UM	80275	84275	81275	82275	91275	23307	01023	41307	92275	01080	83275
300 Norma Mag	80928	84928	81928	82928	91928	24307	01024	41307	92928	01063	N.A.
308 Marlin Express	80294	84294	81294	82294	91294	23307	01023	41307	92294	01079	N.A.
7.65MM x 53 Mauser (Belgian)	80243	84243	81243	82243	91243	23310	01023	41310	92243	01063	83243
7.7MM x 58 Japanese	80244	84244	81244	82244	91244	24310	01024	41310	92244	01080	83244
33 Winchester	80205	N.A.	N.A.	N.A.	91205	23336	01023	41336	92205	01080	83205
338 RCM	80273	84273	81273	82273	91273	23336	01023	41336	92273	01080	N.A.
338-06 Improved 40°	80437	84437	81437	82437	91437	24837*	01024	16336*	92437	01063	83437
338-378 Weatherby Mag	80527	84527	81527	82527	91527	25336	01025	41336	92527	01063	83527
35 Whelen Improved 40°	80438	84438	81438	82438	91438	24856*	01024	16356*	92438	01081	83438
9.3MM x 74R	80346	N.A.	N.A.	N.A.	91346	25364	01025	41364	92346	01064	N.A.
375/444 Marlin	80475	84475	81475	82475	91475	24373	01024	41373	92475	01081	N.A.
375 H & H Improved 40°	80440	84440	81440	82440	91440	25373	01025	41373	92440	01081	N.A.
375 Weatherby Mag	80468	N.A.	N.A.	N.A.	91468	25373	01025	41373	92468	01081	N.A.
375 Remington Ultra Mag	80925	84925	81925	82925	91925	25373	01025	41373	92925	01081	83925
378 Weatherby Mag	80469	84469	81469	82469	91469	25373	01025	41373	92469	01081	N.A.
416 Weatherby Mag	80492	N.A.	N.A.	N.A.	91492	25414	01025	41414	92492	01064	N.A.
460 Weatherby Mag	80480	84480	81480	82480	91480	30456	01030	41456	92480	01065	N.A.
470 Nitro Express	80481	N.A.	N.A.	N.A.	91481	29472	01029	41472	92481	01100	N.A.

SERIES D - Die Sets For Straight Wall Cases

Cartridge	Three Die Set \$156.80	Sizing Die \$78.45	Decap Rod Assembly \$20.40	Seating Die \$76.45	Seat Plug \$13.55	Expander Die \$55.60	Expander \$17.85	Profile Crimp \$71.70	Taper Crimp \$71.70	Trim Die \$89.00
30 Luger	80250	91250	22097	92250	01073	93250	92307	N.A.	N.A.	83250
351 Winchester S.L.	80462	91462	22097	92462	01079	93462	96350	N.A.	N.A.	N.A.
38 Smith & Wesson	80303	91303	22097	92303	01072	93303	92356	N.A.	N.A.	83303
38-56 Winchester	80463	91463	23373	92463	01081	93463	99374	N.A.	N.A.	83463
40 SUPER ♦	80677	91677	22097	92677 ♦	01092	93677	93399	N.A.	85677	N.A.
40-82 Winchester	80482	91482	24404	92482	01081	93482	96405	N.A.	N.A.	83482
401 Winchester S.L.	80471	91471	22097	92471	01081	93471	96405	N.A.	N.A.	83471
405 Winchester	80473	91473	25097	92473	01081	93473	97409	N.A.	N.A.	N.A.
45-60 Winchester	80570	91570	27097	92570	01091	93570	99457	86570	N.A.	83570
45-90 Winchester	80476	91476	28097	92476	01065	93476	99457	N.A.	N.A.	83476
458 Lott	80460	91460	30097	92460	01065	93460	99457	N.A.	N.A.	83460
480 Ruger/475 Linebaugh	80380	91380	21097	92380	01093	93380	94473	86380	N.A.	N.A.

"E-Z Feed" Shellholders



New tapered design allows easy case entry. Machined to very close tolerances to fit your cases perfectly and eliminate potential problems. The universal design fits all popular presses. Only Redding shellholders are heat treated and have outside knurling to make them easy to handle and change. See Reference Charts on pages 20, 21 & 22 for proper size. **ITEM NO. 110XX** (specify shellholder #) **\$14.80**



"E-Z Feed" Shellholder Sets

This set consists of six of the most popular shellholders in a handy storage box. Contains Shellholders #1, #6, #10, #12, #18 & #19.

See Reference Charts on pages 20, 21 & 22 for shellholder usage.

ITEM NO. 11900 **\$80.25**

Shellholder storage box also available separately
ITEM NO. 11699 **5.25**

Carbide Size Button Kits

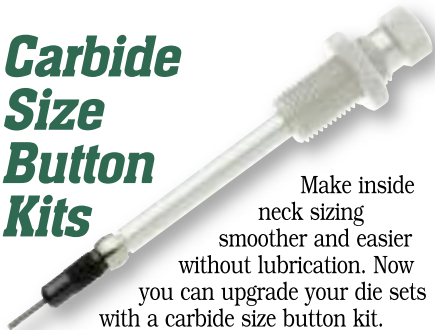

Make inside neck sizing smoother and easier without lubrication. Now you can upgrade your die sets with a carbide size button kit.

Available for bottleneck cartridges 20 thru 338 cal. The carbide size button is free floating on the decap rod allowing it to self-center in the case neck. **Kits contain: carbide size button, retainer and spare decapping pin.**

These kits also fit all Type-S dies \$47.80
Kit No. 47203 20 cal.
Kit No. 48223 22 cal.
Kit No. 482426MM
Kit No. 48256 25 cal.
Kit No. 48263 6.5MM
Kit No. 49276 270 cal.
Kit No. 492837MM
Kit No. 49307 30 cal.
Kit No. 49337 338 cal.

See chart on pages 8 & 9 for Competition Neck Sizing Die Carbide Kit item numbers

Taper Crimp Dies

Designed for handgun cartridges which headspace on the case mouth where conventional roll crimping is undesirable. Also available for some revolver cartridges for those who prefer the uniformity of a taper crimp.



See pages 11 thru 14 & 17 for availability.

Series A **\$42.35** Series B **\$51.30**
Series C **64.55** Series D **71.70**

Profile Crimp Dies

These handgun cartridge crimp dies were designed for those who want the best possible crimp. Profile crimp dies provide a tighter, more uniform roll type crimp, and requires the bullet to be seated to the correct depth in a previous operation. These dies are not for cartridges that headspace on the case mouth.



See pages 11 thru 14 for availability.

Series A **\$42.35** Series B **\$51.30**
Series C **64.55** Series D **71.70**

Extended Shellholders

Extended shellholders are required when trimming short cases under 1 1/2" O.A.L. They are machined to the same tolerances as our standard shellholders except they're longer. See Reference Charts on pages 22 & 23 for proper shellholder number. **NO. 115XX** (specify shellholder #) ... **\$23.40**



Special Profile Crimp Dies

These Special Dies are designed for the 45-70 FTX and 41 Special due to their shorter case length.



ITEM NO. 86776 (41 spl) *New!* **\$71.70**
ITEM NO. 86262 (45-70 FTX) .. **\$51.30**

Tapered Size Buttons



These long tapered expanders (size buttons) are made for expanding the necks of bottleneck cartridges up to the desired size.

Tapered size button only **\$ 20.25**

Decapping rod assembly with tapered size button, **specify cartridge \$ 28.90**

22 cal...(.17 to 22 cal.) NO. 19223
6mm...(.17 to 6 mm) NO. 19242
25 cal...(.22 to 25 cal.) NO. 19256
6.5mm...(.22 to 6.5mm) NO. 19263
270 cal...(.22 to .270) NO. 16276
7mm...(.22 to 7mm) NO. 16283
30 cal...(.6mm to 30 cal.) NO. 16307
8mm...(.25 cal. to 8mm) NO. 16322
338 cal...(.65 to .338) NO. 16336
35 cal...(.7mm to 35 cal.) NO. 16356
9.3mm...(.30 cal. to 9.3mm) NO. 16364
375 cal...(.30 cal. to .375 cal.) . . . NO. 16373

Trim Dies

Redding trim dies allow you to file trim your cases without unnecessary resizing. Other manufacturers use sizing die dimensions, forcing you to full length resize when trimming. For case forming and necking brass down from another caliber, Redding trim dies can be the perfect intermediate step before full length resizing. Pistol trim dies require extended shellholders. Refer to die charts for available calibers and the extended shellholders required. See our case forming section on page 23.

Series A **\$ 47.70** Series B **\$ 64.55**
Series C **80.55** Series D **89.00**

Universal Decapping Dies

Decapping dies allow you to deprime and clean your cases prior to sizing.

The small decapping die will handle 22 thru 50 caliber cases with lengths up to 2.625". An optional decapping rod for this die is designed to work with all 17 caliber cases and will accommodate the small .060" flash holes found on the BR and PPC cases. For longer case lengths up to 3.0" use the large decapping die. **Note: the large die will not accommodate a neck diameter of less than 25 caliber.**

ITEM 69100 Small decapping die ... **\$28.90**
ITEM 69200 Large decapping die **28.90**
ITEM 69250 Optional 17 caliber rod .. **14.65**
Complete kit containing all of the above items
ITEM 69500 **\$68.35**



New! Premium Die Sets

Featuring a Carbide Size Button in the full length sizing die and the Bullet Seating Micrometer on the seating die.

Following the introduction of Bullet Seating Micrometers for our standard series of seating dies, our customers have been asking for complete die sets with this added precision.

We have now added two popular upgrades to a select group of dies to create the new "Premium" Die Sets.

The upgrades include combining a **Carbide Size Button** in the full length sizing die and the **Bullet Seating Micrometer** on the seating die.

Two types of "Premium" Die Sets are available.

The **"Premium" Full Length**, two (2) die set; contains a carbide Size Button in the full length sizing die and the Bullet Seating Micrometer on the seating die.

See Chart for availability . . . \$150.55

The **"Premium" Deluxe**, three (3) die set; contains the "Premium" two (2) die set (described above) with the addition of a standard neck sizing die.

See Chart for availability . . . \$194.55



Cartridge	Premium Full Length Die Set	Premium Deluxe Die Set	Cartridge	Premium Full Length Die Set	Premium Deluxe Die Set	Cartridge	Premium Full Length Die Set	Premium Deluxe Die Set
204 Ruger	66287	68287	260 Remington	66531	68531	7MM Remington Mag	66136	68136
22 Nosler	66768	68768	<i>New!</i> 6.5 Creedmoor	66446	68446	30-06 Springfield	66148	68148
222 Remington	66109	68109	6.5MM x 55 Swedish	66132	68132	300 WSM	66223	68223
22-250 Rem	66106	68106	6.5MM/284 Win (Norma)	66415	68415	300 Winchester Mag	66153	68153
223 Remington	66111	68111	270 WSM	66255	68255	300 Rem Ultra Mag	66288	68288
243 Winchester	66114	68114	270 Winchester	66135	68135	308 Winchester	66155	68155
25-06 Remington	66120	68120	<i>New!</i> 280 Ackley Improved	66428	68428	338 Winchester Mag	66163	68163
<i>New!</i> 26 Nosler	66261	68261	7MM-08 Remington	66139	68139			

Bullet Seating Micrometers



New! Now available for handgun and straight wall cartridges.

Redding **Bullet Seating Micrometers** are for use with most standard Redding Seating Dies and provide a direct replacement for the original seat plug.

Redding **Bullet Seating Micrometers** for bottleneck cartridges are available for traditional bullet shapes (STD) and for VLD bullet shapes (VLD). They are also available for handgun and straight wall cartridges with traditional bullet shapes (STD) and flat nose bullet designs (FLAT).

Not for use with our Competition Seating Dies.

See chart for ordering numbers . . . \$56.55

Original Seat Plug Item No. - (Plug No.)	Micrometer Item No.		
	(Std)	(VLD)	(FLAT)
01063 - (#3)*	09063	09163	N.A.
01065 - (#5)*	09065	N.A.	09465
01066 - (#6)*	09066	09166	N.A.
01067 - (#7)*	09067	09167	N.A.
01069 - (#9)*	09069	N.A.	N.A.
01071 - (#11)*	09071	N.A.	09471
01072 - (#12)*	09072	N.A.	N.A.
01073 - (#13)*	09073	N.A.	09473
01074 - (#14)*	09074	N.A.	09474
01075 - (#15)*	09075	N.A.	09475
01076 - (#16)*	09076	N.A.	09476
01077 - (#17)*	09077	N.A.	09477
01079 - (#19)*	09079	09179	N.A.
01080 - (#20)*	09080	09180	N.A.
01081 - (#21)*	09081	N.A.	N.A.
01083 - (#23)*	09083	09183	N.A.
01084 - (#24)*	09084	09184	N.A.
01085 - (#25)*	09085	09185	N.A.
01092 - (#32)*	09092	N.A.	N.A.
01096 - (#36)*	09096	N.A.	N.A.

*Note: Your original (Plug No.) is marked on top.

Master Hunter Die Sets

With the extraordinary Competition Seating Die

The Master Hunter Die Sets were inspired by and requested as a result of the success of our National Match Die Sets.

Experienced hunters know that full length resizing is important when a high stress follow-up shot is needed in the "real world" of Hunting.

As a result, the upgraded Master Hunter Die Sets combine the standard Redding Full Length Sizing Die with the extraordinary Redding Competition Seating Die enabling you to make the best possible ammunition for your favorite hunting rifle.

See chart for available cartridges **\$215.50**

Master Hunter Die Set

CONTAINS –

- Standard Full Sizing Die
- Competition Seating Die

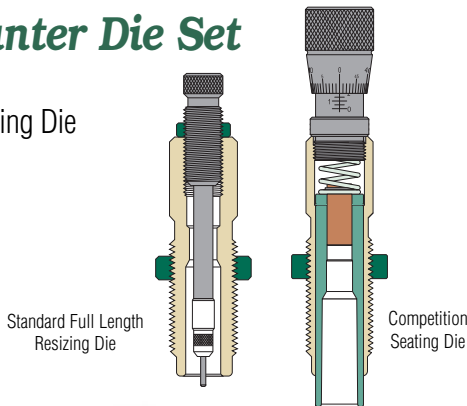

Cartridge	Die Set Item No.	Full Length Sizing Die	Competition Seating Die
<i>New!</i> 22 Nosler	28768	91768	55768
223 Remington	28111	91111	55111
22-250 Remington	28106	91106	55106
243 Winchester	28114	91114	55114
25-06 Remington	28120	91120	55120
260 Remington	28531	91531	55531
26 Nosler	28261	91261	55261
<i>New!</i> 6.5 Creedmoor	28446	91446	55446
6.5 x 55 Swedisch	28132	91132	55132
<i>New!</i> 6.5MM/284 Winchester (Norma)	28415	91415	55415
270 Winchester	28135	91135	55135
7MM-08 Remington	28139	91139	55139
280 Remington	28142	91142	55142
<i>New!</i> 280 Ackley Improved	28428	91428	55428
7MM Remington Mag	28136	91136	55136
<i>New!</i> 28 Nosler	28790	91790	55790
30 Nosler	28817	91817	55817
308 Winchester	28155	91155	55155
30-06 Springfield	28148	91148	55148
300 Winchester Mag	28153	91153	55153
300 Weatherby Mag	28252	91252	55252
300 Rem Ultra Mag	28288	91288	55288
300 WSM	28223	91223	55223
<i>New!</i> 33 Nosler	28799	91799	55799
<i>New!</i> 338 Winchester Mag	28163	91163	55163

National Match (NM-C) Die Sets

New! Now supplied with carbide size buttons

The success of our specialized National Match Die Sets has created the demand for us to offer additional options beyond the limits of sanctioned cartridges to meet the needs of other precision oriented AR platform shooters.

The name change (NM-C) indicates that all of our National Match Die Sets are now supplied with carbide size buttons. The sets include: a full length Sizing Die with carbide size button, the Competition Bullet Seating Die and a Taper Crimp Die.

Category I **\$281.30** Category II **\$312.65**

National Match (NM-C) Die Set

CONTAINS –

- Standard Full Sizing Die with Carbide Size Button
- Competition Seating Die
- Taper Crimp Die

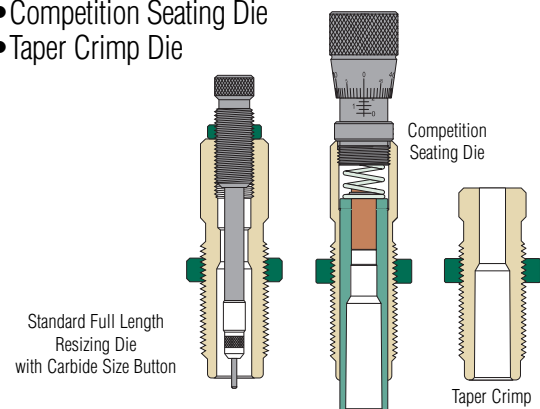

Cartridge	Die Set Item No.	Taper Crimp Die
Category I		
204 Ruger	39287	85287
<i>New!</i> 22 Nosler	39768	85768
223 Remington	39111	85111
243 Winchester	39114	85114
260 Remington	39531	85531
<i>New!</i> 6.5 Creedmoor	39446	85446
7MM-08 Remington	39139	85139
308 Winchester	39155	85155
30-06 Springfield	39148	85148
Category II		
6.5 GRENDEL™	39478	85478
6.8MM Remington SPC	39259	85259
300 Blackout	39327	85327

Note: For the ultimate shoulder bump control, use these dies with our new Competition Shellholders. See page 18 for details.



— Tech Talk —

Create The Perfect Shoulder Bump With A Simple Shellholder Change!

To maximize case life and the accuracy potential of your reloads, it is desirable to size fired cases the minimum amount that allows loaded cartridges to chamber freely.

Most hunters and many other shooters seeking smooth chambering reloads, full length size their cases each time. Since the interior dimensions of sizing dies are determined by the manufacturer, adjusting the *shoulder setback* is the only control a reloader has over how much a fired case is sized.

In the past, sizing die adjustment was made through the trial and error method of adjusting the die body in the reloading press. While acceptable results can be obtained using this method, precise adjustments were difficult at best. Using this method, firm contact with the shellholder (squaring the die) was not always possible. As a result, irregularities in brass hardness and thickness, as well as the uniformity of case lube affected shoulder setback. The resulting headspace variations created can adversely affect accuracy.

To provide desirable shellholder-to-die contact during sizing, without excessively setting the case shoulder back, Redding now produces shellholders that are made in increments of .002" deeper than the industry standard. The nominal industry standard depth (dimension X) for shellholders is .125". The new Competition Shellholder Set includes five shellholders that are deeper than this in increments of .002". Therefore, the set includes shellholders that are marked +.002, +.004, +.006, +.008 and +.010, which is the amount the shellholder will increase base to shoulder case length and thus decrease shoulder set back and case to chamber headspace.

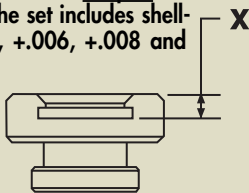

To select the proper shellholder for your particular firearm's chamber, simply start with the shellholder marked +.010. The shellholder should be adjusted to make firm contact with the bottom of the sizing die during the case sizing operation. Resize a case and try it (unprimed and empty) in the chamber of your firearm. If the empty case does not chamber or chambers with difficulty, switch to the shellholder marked +.008 and repeat the process. Stop at the shellholder that allows the firearm's action to close freely. Your cases are now being sized properly to fit your chamber with a minimum amount of headspace.

Establish the perfect shoulder bump with no die adjustment!

Competition Shellholder Sets

You control the headspace. The easy to use Redding Competition Shellholders enable you to perfectly match the headspace of your reloaded ammo to any firearm. Once the proper shellholder is determined your results are repeatable and no die adjustment is necessary. Each shellholder has a distinct black oxide finish and is clearly marked to indicate the amount it will change case-to-chamber headspace – no special tools or gages are needed.

Packaged in five piece sets in .002" increments.

ITEM NO. 116XX (5 pc. set includes storage box) \$85.65

Shellholder storage box also available separately.

ITEM NO. 11699 \$5.25

Competition Shellholder Sets now available in the following sizes:

#1, 2, 4, 6, 7, 10, 12, 18 & 35

For order No., replace XX with shellholder number from charts on pages 20, 21 & 22.

Special Small Base Body, Full Length & Type S – Full Length Dies

Now available in the following calibers for firearms with custom chamberings that are tighter than SAAMI specifications.

Note: For the ultimate shoulder bump control, use these dies with our new Competition Shellholders. See above for details.



Small Base Body & Full Length Dies

Cartridge Group 1	Small Base Body Die \$58.80	Small Base Full Length \$72.25
223 Remington	74111	91323
260 Remington	74531	N.A.
308 Winchester	74155	91355
30-06 Springfield	74148	N.A.

Group 2	\$72.25	\$91.25
22 P.P.C.	N.A.	91301
6MM P.P.C.	74319	91211
6MM B.R. Remington	74317	91201
6MM/284 Winchester	74414	N.A.
6.5MM/284 Winchester (Norma)	74415	N.A.
284 Winchester	74141	N.A.

Small Base Type S - Full Length Dies

223 Remington	77323	\$113.25
308 Winchester	77355	\$113.25
6MM B.R. Remington	77201	\$113.25
6MM P.P.C.	77211	\$113.25

“Custom Series” Dies “Custom Series” Dies Prices

Our Series “C” and “D” listings contain many obsolete and wildcat cartridges normally considered custom by other manufacturers. We try to maintain limited quantities of factory inventory on “Custom Series” Dies listed in this catalog on pages 20 thru 22. “Custom Series” Die prices are shown at the right.

Custom Two Die Sets	\$ 204.65 *
Custom F.L. Sizer or Neck Sizer	\$ 133.25 *
Custom “Type S” Neck or F.L. Sizer	\$ 180.90 *
Custom “Type S” Neck Die Set	\$ 348.85 *
Custom Deluxe Die Set	\$ 323.25 *
Custom Three Die Set (straight wall cases)	\$ 219.60
Custom Seating Die	\$ 114.75
Custom Taper Crimp Die or Body Die	\$ 93.25
Custom Form Die	\$ 93.25
Custom Form and Trim Die	\$ 115.55
Special Price Group (*)	\$ 226.70

* Add \$8.95 for Tapered Size Button

Special “One Off” (one of a kind) Custom Dies

Any custom dies (not listed in this catalog) are considered non series or “One Off” (one of a kind) Custom Dies and are priced in a manner reflecting the direct cost associated with their design and manufacture. To purchase “One Off” Custom Dies you will be required to supply the chamber reamer drawing for your cartridge or five (5) fired cases from your chamber in order for us to provide an accurate design. All “One Off” Custom Dies must be fully paid for at the time of your order by check or money order (credit cards are not accepted). You must call, write or e-mail for a price quotation on any “One Off” Custom Die. Since these items are not run on a standard production basis, lead time will be a minimum of 16 weeks after receipt of payment.

Redding reserves the right to decline production of any die or die set which the company feels may produce a cartridge case with inherent design flaws or safety concerns.

Designed for shooters seeking the utmost in accuracy from their handloads.

Instant Indicator – Headspace and Bullet Seating Depth Comparator

This instrument provides an extremely fast and accurate method for comparing the shoulder position of fired and/or sized cases and bullet seating depth uniformity. The addition of the “Range Adapter” makes this instrument more versatile and may now be used at the range or in the field without requiring the use of a reloading press.

Quickly perform any of the following tasks.

- Check uniformity of shoulder bump
- Check bullet seating depth uniformity
- Compare sized cases to fired cases to determine the amount of headspace
- Sort cases fired in two or more rifles
- Sort sized cases for uniformity
- Set up sizing die correctly
- Check trim length uniformity
- Sort bullets for uniformity

New! Now Supplied with the new “Range Adapter” for added versatility!

All Instant Indicators also include one bore diameter bushing, surface contactor, shoulder contactor, headspace gauge and complete instructions.

“Instant Indicator” w/Dial Indicator	ITEM NO. 27XXX	\$206.85
w/o Dial Indicator	ITEM NO. 17XXX	160.00
1” Dial Indicator	ITEM NO. 17999	52.30
Range Adapter	ITEM NO. 17014	14.80



Cartridge availability and ordering numbers Note: The “Instant Indicator” may be used on a family of cartridges with the same shoulder angle.

Cartridge	Item No.	w/o Indicator	Cartridge	Item No.	w/o Indicator	Cartridge	Item No.	w/o Indicator
204 Ruger	27287	17287	257 Roberts	27125	17125	7MM Rem Mag	27136	17136
222 Rem	27109	17109	257 Rob Imp 40°	27322	17322	308 Winchester	27155	17155
223 Rem	27111	17111	25-06 Remington	27120	17120	30-06 Springfield	27148	17148
223 WSSM	27295	17295	260 Remington	27531	17531	300 Rem SA UM	27275	17275
22-250 Rem	27106	17106	6.5 Creedmoor	27446	17446	300 WSM	27223	17223
220 Swift	27107	17107	6.5 x 47 Lapua	27479	17479	300 Win Mag	27153	17153
243 Win	27114	17114	6.5MM x 55	27132	17132	300 Wby Mag	27252	17252
243 Win Imp 40°	27420	17420	6.5MM/284 NORMA (Win)	27415	17415	300 Rem Ultra Mag	27288	17288
243 WSSM	27270	17270	270 Win	27135	17135	338 Win Mag	27163	17163
6MM P.P.C.	27319	17319	280 Ackley Improved	27428	17428	338 Lapua Mag	27594	17594
6MM B.R. Rem	27317	17317	7MM-08 Rem	27139	17139			
6MM Remington	27115	17115	7MM x 57	27138	17138			

Die Caliber Reference Chart

Cartridge	Series	Shellholder	Caliber	Pilot No.
17 Remington	B	#10	17 Cal.	15168
17 Hornet	B	#14		
17 Ackley Hornet	Custom	#14		
17 Bumble Bee	Custom	#3		
17 Ackley Bee	Custom	#3		
17 Mach IV	D	#10		
17 Javelina	Custom	#10		
17 He Bee	Custom	#3		
17 P.P.C.	Custom	#12		
17/221 Remington	Custom	#10		
17 Remington Fireball	B	#10		
17 Tactical	Custom	#10		
17/222 Remington	Custom	#10		
17/222 Remington Mag	Custom	#10		
17/223 Remington	Custom	#10		
17 B.R.	Custom	#1	17 Cal.	15168
20 Ackley Hornet	Custom	#14	20 Cal.	15200
20 Vartarg	Custom	#10		
20 Tactical	C	#10		
204 Ruger	A	#10		
20 P.P.C.	Custom	#12		
20 B.R.	Custom	#1	20 Cal.	15200
22 TCM	Custom	#10	22 Cal.	15220
218 Bee	B	#3		
218 Mashburn Bee	Custom	#3		
219 Zipper	C	#2		
219 Zipper Improved 28°	Custom	#2		
219 Donaldson Wasp	D	#2		
219 Donaldson Wasp Short (Original)	D	#2		
22 Cheetah Mark I (40°)	Custom	#1		
22 Cheetah Mark II (28°)	Custom	#1		
22 Hornet	A	#14		
22 K-Hornet	B	#14		
22 Lovell 2R (22-3000 G&H)	Custom	#10		
22 B.R. Remington	B	#1		
22 Remington Jet	Custom	#12		
22 Dasher	Custom	#1		
22 Nosler	B	#10		
22 P.P.C. USA	B	#12		
22 Waldog	Custom	#12		
22 Savage H.P. (5.6MM x 52R)	D	#2		
22 Wampus Kitty	Custom	#1		
22 ULA Honeybee	Custom	#1		
220 Swift	A	#4		
220 Swift Imp 40°	Custom	#4		
220 Swift Imp 32°	Custom	#4		
220 Russian (5.6MM x 39)	Custom	#12		
220 Weatherby Rocket	Custom	#4		
220 Wilson Arrow	Custom	#4		
22-250 Remington	A	#1		
22-250 Improved 40°	C	#1		
22-250 Improved 28°	Custom	#1		
22/240 Weatherby Mag	Custom	#1		
22/243 Winchester	Custom	#1		
22/243 Improved 40°	Custom	#1		
22/6MM Remington	Custom	#1		
22/6MM Improved 40°	Custom	#1		
22/243 Middlested 30°	Custom	#1		
22/284 Winchester	Custom	#1		
22/30-30 Winchester	Custom	#2		
221 Remington Fireball	A	#10		
222 Remington	A	#10		
222 Remington Mag	C	#10		
223 Remington	A	#10		
223 Remington Improved 40°	D	#10		
223 WSSM	C	#6		
224 Clark	Custom	#1		
224 Weatherby Mag	D	#12		
225 Winchester	C	#4		
5.6 x 50 R Mag	Custom	#12		
5.6 x 57 RWS	Custom	#1		
5.7 x 28	D	#34		
5.7MM Johnson (22 Spitfire)	Custom	#22	22 Cal.	15220
240 Weatherby Mag	C	#1	6MM	15239
240 Gibbs	Custom	#1		
240 Page Super Pooper	Custom	#1		
243 Winchester	A	#1		
243 Winchester Improved 40°	C	#1		
243 Improved 30°	Custom	#1		
243 Catbird	Custom	#1		
243 WSSM	C	#6		
6mmXC	D	#1		
6MM Bullberry	Custom	#2		
6MM Mashburn Mag	Custom	#1		
6MM Remington	A	#1		
6MM Remington Improved 40°	D	#1		
6MM Remington Improved 30°	Custom	#1		
6MM TCU	C	#10		
6MM SM Wasp	Custom	#2		
6MM Wasp	Custom	#2	6MM	15239

Cartridge	Series	Shellholder	Caliber	Pilot No.
6MM Creedmoor	C	#1	6MM	15239
6MM B.R. Remington	B	#1		
6MM Dasher	Custom	#1		
6MM P.P.C. USA	B	#12		
6MM International (Walker)	Custom	#1		
6MM Cheetah Mark I (40°)	Custom	#1		
6MM/224 Weatherby	Custom	#4		
6MM/222 Remington	Custom	#10		
6MM/223 Remington (6MM x 45MM)	C	#10		
6MM/225 Winchester	Custom	#4		
6MM/22-250 Remington	Custom	#1		
6MM/22-250 Improved 28° or 40°	Custom	#1		
6MM/284 Winchester	Custom	#1		
6MM/30-30 Winchester	Custom	#2		
6MM/30-30 Win Improved 40°	Custom	#2		
6MM/300 WSM	Custom	#6		
6MM x 44 BR	Custom	#1		
6MM x 47 Swiss Match	Custom	#1		
6MM x 47 Lapua	• D	#1		
6MM x 47 (6MM-222 Rem Mag)	Custom	#10		
6MM x 62 Freres	Custom	#7		
6MM/06	Custom	#1		
6MM/06 Improved 40°	Custom	#1	6MM	15239
25 Remington	D	#5	25 Cal.	15253
25 Bullberry	Custom	#2		
25 TCU	Custom	#10		
25 B.R.	Custom	#1		
25 Souper (25/308 Win)	Custom	#1		
25 WSSM	C	#6		
25 Gibbs	Custom	#1		
25-06 Remington	A	#1		
25-06 Remington Improved 40°	D	#1		
25-20 Winchester	C	#3		
25-20 Single Shot	Custom	#10		
25-35 Winchester	D	#2		
25-35 Ackley Improved 40°	Custom	#2		
25-36 Marlin	Custom	#2		
25/221 Remington	Custom	#10		
25/222 Remington	Custom	#10		
25/222 Remington Mag	Custom	#10		
25/223 Remington (25-45 Sharps)	Custom	#10		
25/225 Winchester	Custom	#4		
25/243 Improved 40°	Custom	#1		
25/284 Winchester	D	#1		
25/300 WSM	Custom	#6		
25/300 Rem SA UM*	Custom	#6		
25/300 Rem Ultra Mag	Custom	#6		
25/308 Winchester	Custom	#1		
250 Savage (250-3000)	B	#1		
250 Savage Improved 40°	D	#1		
250 Savage Improved 28°	Custom	#1		
256 Winchester Mag	B	#12		
257 Roberts	A	#1		
257 Roberts Improved 40°	C	#1		
257 Weatherby Mag	B	#6		
257 STW	Custom	#6		
257 Kimber	Custom	#10		
257 Durham Jet	Custom	#1	25 Cal.	15253
256 (6.5MM) Newton	Custom	#1	6.5MM	15260
260 Bobcat	Custom	#1		
260 Remington	A	#1		
260 Remington Improved 40°	D	#1		
264 Jarrett	Custom	#1		
264 Winchester Mag	B	#6		
26 Nosler	B	#6		
6.5 Grendel™	C	#12		
6.5 Bullberry	Custom	#2		
6.5 Creedmoor	A	#1		
6.5MM Gibbs	Custom	#1		
6.5MM IHMSA	Custom	#1		
6.5MM B.R.	Custom	#1		
6.5MM x 47 Lapua	C	#1		
6.5MM Remington Mag	D	#6		
6.5MM TCU	Custom	#10		
6.5MM/22-250 Improved 40°	Custom	#1		
6.5-06 (A-Square)	C	#1		
6.5MM/06 Improved 35° or 40°	Custom	#1		
6.5MM x 39 (M.O.A.)	Custom	#12		
6.5MM x 50 Japanese	D	#4		
6.5MM x 52 Carcano	Custom	#1		
6.5MM x 54 Mannlicher	D	#24		
6.5 X 55 Swedish	A	#7		
6.5 X 55 Swedish Improved 40°	Custom	#7		
6.5MM X 55 SKAN	Custom	#1		
6.5MM x 57 Mauser	D	#1		
6.5MM x 64 Brenneke	Custom	#1		
6.5MM x 65 RWS	Custom	#1		
6.5MM x 68	Custom	#19		
6.5MM/223 Remington	Custom	#10		
6.5MM/243 WSSM	Custom	#6		
6.5MM/250 Savage	Custom	#1		
6.5MM STW	Custom	#6	6.5MM	15260

Die Caliber Reference Chart

Cartridge	Series	Shellholder	Caliber	Pilot No.	Cartridge	Series	Shellholder	Caliber	Pilot No.
6.5MM Redding (6.5/243 Imp. 30°)	Custom	# 1	6.5MM	15260	30/284 Winchester	Custom	# 1	30 Cal.	15304
6.5MM/257 Roberts	Custom	# 1			30/338 Winchester Mag	C	# 6		
6.5MM/257 Roberts Imp. 40°	Custom	# 1			30 Nosler	B	# 6		
6.5MM/284 Win (Norma)	A	# 1			30/8MM Rem Mag (30 Super)	Custom	# 6		
6.5MM/300 WSM	Custom	# 6			30/350 Remington Mag	Custom	# 6		
6.5MM/300 Rem SA UM*	Custom	# 6			30-378 Weatherby Mag	C	#18		
6.5MM/300 Weatherby Mag	D	# 6			300/221 Remington	D	#10		
6.5MM/300 Rem Ultra Mag	Custom	# 6			300 Blackout	B	#10		
6.5MM/308 Win	Custom	# 1			300 H & H Magnum	B	# 6		
6.5MM/308 Improved 30° or 40°	Custom	# 1	6.5MM	15260	300 H & H Improved 40°	Custom	# 6		
6.8MM Remington SPC	B	# 5	270 Cal.	15273	300 Savage	B	# 1		
270 Redding (270/243 Imp. 30°)	Custom	# 1			300 Dakota *	Custom	#404		
270 Winchester	A	# 1			300 Winchester Mag	A	# 6		
270 Winchester Improved 40°	Custom	# 1			300 Winchester Imp. 40°	Custom	# 6		
270 Weatherby Mag	B	# 6			300 Weatherby Mag	A	# 6		
270 Gibbs	Custom	# 1			300 Mashburn Mag	Custom	# 6		
270 Jarrett	Custom	# 1			300 Kong *	Custom	#18		
270 IHMSA	Custom	# 1			300 Herrett	Custom	# 1		
270/257 Roberts Improved 40°	Custom	# 1			300 Jarrett	Custom	# 6		
270/284 Winchester	Custom	# 1			300 Pegasus *	Custom	#35		
270 WSM	A	# 6			300 Baer *	Custom	#35		
270/300 Weatherby	Custom	# 6			300 Rem SA UM	D	# 6		
270/300 Rem Ultra Mag	Custom	# 6			300 Lapua Mag	Custom	#35		
270/308 Winchester	Custom	# 1			300 Remington Ultra Mag	A	# 6		
270/308 Improved 40°	Custom	# 1			300 RCM	D	# 6		
270/338 Winchester	Custom	# 6	270 Cal.	15273	300 WSM	A	# 6		
280 Remington	A	# 1	7MM	15280	300 Norma Mag	D	#35		
280 Ackley Improved	B	# 1			303 Savage	C	#21		
280/30 British	Custom	# 1			308 Marlin Express	D	#2		
284 Winchester	B	# 1			308 Winchester/307 Winchester	A	#1 & #2		
28 Nosler	B	# 6			308 Winchester Imp. 40°	Custom	# 1		
284 Baer	Custom	# 6			308 Norma Mag	B	# 6		
7MM Remington Mag	A	# 6			308 x 1.5 Barnes	Custom	# 1		
7MM US	Custom	# 2			308 x 1.75	Custom	# 1		
7MM B.R. Remington	B	# 1			30/338 Lapua Mag *	Custom	#35		
7MM TCU	D	#10			30/416 Rigby Improved 40° *	Custom	#35	30 Cal.	15304
7MM ULA	Custom	# 6			7.65MM x 53 Mauser (Belgian)	D	# 1	31 Cal.	15307
7MM INT-R	Custom	# 2			7.7MM x 58 Japanese	D	# 1		
7MM INT-X	Custom	# 1			303 British	B	# 8	31 Cal.	15307
7MM Super Mag	Custom	#12			32 Winchester Spec.	C	# 2	8MM	15319
7MM E.T. Gates	Custom	# 2			32 Remington	C	# 5		
7MM Dakota *	Custom	#404			32-40 Winchester	C	# 2		
7MM IHMSA	Custom	# 1			325 WSM	B	# 6		
7MM/300WSM	Custom	# 6			7.92MM x 33 Kurz Mauser	Custom	# 1		
7MM Rem SA UM	B	# 6			8MM Gibbs	Custom	# 1		
7MM WSM	B	# 6			8MM Remington Mag	Custom	# 6		
7MM Weatherby Mag	C	# 6			8MM Lebel	Custom	#26		
7MM Gibbs	Custom	# 1			8MM/06	Custom	# 1		
7MM Remington Ultra Mag	B	# 6			8MM/06 Improved 40°	Custom	# 1		
7MM STW (Shooting Times)	B	# 6			8MM/338 Winchester	Custom	# 6		
7MM-08 Remington	A	# 1			8MM/300 Winchester Mag	Custom	# 6		
7MM-08 Improved 30°	Custom	# 1			8MM/300 WSM	Custom	# 6		
7MM-08 Remington Imp. 40°	D	# 1			8MM x 52 R Siamese	Custom	#18		
7-30 Waters	C	# 2			8MM x 56 Mannlicher	Custom	# 6		
7-30 Improved 40°	Custom	# 2			8MM x 57 Mauser	A	# 1		
7MM x 47 (7MM-222 Rem Mag)	Custom	#10			8MM x 57 Improved 40°	Custom	# 1		
7MM x 57 Mauser	A	# 1 (Rimmed #6)			8MM x 60S	Custom	# 1		
7MM x 57 Improved 40°	D	# 1			8MM x 64S Brenneke	Custom	# 4		
7MM x 61 Sharpe & Hart	Custom	# 6			8MM x 68S	Custom	#19		
7MM x 64 Brenneke	C	# 1			8.15 x 46R	Custom	# 2	8MM	15319
7MM x 66 Vom Hofe S.E.	Custom	# 6			33 Winchester	D	#18	338 Cal.	15334
7MM Blaser Mag	Custom	# 6			33 Nosler	B	# 6		
7MM/223 Remington	Custom	#10			330 Dakota *	Custom	#404		
7MM/250 Savage	Custom	# 1			338 Winchester Mag	A	# 6		
7MM/300 Weatherby Mag	D	# 6			338 IHMSA	Custom	# 1		
7MM/300 Winchester	Custom	# 6			338 Gibbs	Custom	# 1		
7MM/300 Remington Ultra Mag	Custom	# 6			338 Baer	Custom	# 6		
7MM/350 Remington Mag	Custom	# 6	7MM	15280	338 Jarrett	Custom	# 6		
7.35MM Carcano	Custom	#24	7.35MM	15295	338-06 (A-Square)	C	# 1		
7.5 French MAS (7.5 x 54)	Custom	# 7	30 Cal.	15304	338-06 Improved 40°	D	# 1		
7.5 x 55 Swiss (K-31)	C	# 2			338-270 HGT	Custom	# 1		
7.62MM x 39	B	#12			338/284 Winchester	Custom	# 1		
7.62MM Russian (7.62MM x 54R)	B	#15			338/308 Winchester	Custom	# 1		
30 B.R.	Custom	# 1			338 Federal	B	# 1		
30 IHMSA	Custom	# 1			338 Marlin Express	Custom	# 36		
30 Herrett	Custom	# 2			338 Norma Mag	Custom	# 35		
30 Remington	D	# 5			338 RCM	D	# 6		
30 Remington AR	D	# 33			338/300 WSM	Custom	# 6		
30 Gibbs	Custom	# 1			338/8MM Remington Mag	Custom	# 6		
30 Hart Mag	Custom	# 6			338/300 Winchester Mag	Custom	# 6		
30 x 44 B.R.	Custom	# 1			338/300 Ultra Mag	Custom	# 6		
30-06 Springfield	A	# 1			338/350 Remington Mag	Custom	# 6		
30-06 Improved 40°	C	# 1			338/378 Weatherby Mag	D	#18		
30-30 Winchester (30 WCF)	A	# 2			340 Weatherby Mag	B	# 6		
30-30 Improved 40°	Custom	# 2			338 Lapua Mag	C	#35		
30-40 Krag	C	# 8			338 Lapua Mag Imp 40° (Call to verify version)	Custom	#35		
30/223 Remington	Custom	#10	30 Cal.	15304	338 Remington Ultra Mag	B	# 6	338 Cal.	15334

Die Caliber Reference Chart

Cartridge	Series	Shellholder	Caliber	Pilot No.
348 Winchester	C	#20	348 Cal.	15344
35 Remington	B	#1	35 Cal.	15354
35 Winchester	C	#8		
35 Whelen	B	#1		
35 Whelen Improved 40°	D	#1		
35 IHMSA	Custom	#1		
35 Brown Whelen	Custom	#1		
35/284 Winchester	Custom	#1		
35/30-30 Winchester	Custom	#2		
35/8MM Remington Mag	Custom	#6		
35/338 Winchester Mag	Custom	#6		
35/300 Weatherby	Custom	#6		
358/25 WSM	Custom	#6		
35/300 WSM	Custom	#6		
350 Remington Mag	B	#6		
357 Herrett	Custom	#2		
358 Dakota *	Custom	#404		
358 Winchester/356 Winchester	B	#1 & #2		
358 Winchester Imp. 40°	Custom	#1		
358 Norma Mag	C	#6		
358 STA (Shooting Times)	Custom	#6		
9MM x 56 Mannlicher	Custom	#1		
9MM x 57 Mauser	C	#1	35 Cal.	15354
9.3MM x 57 Mauser	Custom	#1	9.3MM	15362
9.3MM x 62 Mauser	C	#1		
9.3MM x 64 Brenneke	Custom	#33		
9.3MM x 74R	D	#6		
370 SAKO Mag	Custom	#1	9.3MM	15362
9.5MM Mannlicher	Custom	#1	375 Cal.	15371
375 Dakota *	Custom	#404		
375 Whelen	Custom	#1		
375 Whelen Improved 40°	Custom	#1		
375 H & H Magnum	A	#6		
375 H & H Magnum Imp. 40°	D	#6		
375 Mashburn Mag	Custom	#6		
375 Weatherby Mag	D	#6		
375/284 Winchester	Custom	#1		
375/300 Winchester Mag	Custom	#6		
375/300 WSM	Custom	#6		
375 Ruger	B	#6		
375 Remington Ultra Mag	D	#6		
375/8MM Remington Mag	Custom	#6		
375/338 Winchester	Custom	#6		
375/350 Remington Mag	Custom	#6		
375/444 Marlin	D	#19		
378 Weatherby Mag	D	#18	375 Cal.	15371
416 Remington Mag	C	#6	416 Cal.	15412
416 Ruger	B	#6		
416 Weatherby Mag	D	#18		
416/300 Rem Ultra Mag*	Custom	#6		
416/300 WSM	Custom	#6		
416 Hoffman	Custom	#6		
416 Taylor	Custom	#6		
416 Jarrett	Custom	#18		
416 Rigby *	Custom	#35		
416 Dakota *	Custom	#404		
416 Express	Custom	#6	416 Cal.	15412
404 Jeffery *	Custom	#404	N.A.	N.A.
425 Express *	Custom	#6	N.A.	N.A.
458 SOCOM	C	#1	458 Cal.	15454
458 African *	Custom	#6		
450 Ackley Magnum	Custom	#6		
450 Rigby *	Custom	#35		
450 Dakota *	Custom	#18		
460 Weatherby Mag	D	#18	458 Cal.	15454
470 Nitro Express	D	#31	475 Cal.	15471

THREE DIE SETS

25 ACP (25 Auto)	Custom	#27	N.A.	N.A.
25 Hornet	Custom	#14	25 Cal.	15253
30 M1 Carbine	A	#22	30 Cal.	15304
7.65MM French MAS Auto	Custom	#14		
30 Luger	D	#13		
30 Mauser (7.62 X 25)	C	#13	30 Cal.	15304
32 Short Colt	Custom	#10	N.A.	N.A.
32 Long Colt	Custom	#10	N.A.	N.A.
32 ACP	B	#22	31 Cal.	15307
32 Smith & Wesson (Short)	Custom	#10		
32 Smith & Wesson Long	A	#10		
32 H & R Magnum	A	#10		
32 S & W Long/32 H & R Mag	A	#10		
32-20 Winchester	B	#3	31 Cal.	15307

Cartridge	Series	Shellholder	Caliber	Pilot No.
8MM Lebel Revolver	Custom	#3	N.A.	15319
8MM Nambu	Custom	#5	N.A.	15319
38 Super Auto	B	#5	9MM	15351
380 Auto	B	#10		
9MM Steyr	Custom	#13		
9MM Luger	A	#13		
9MM x 18 Ultra	Custom	#10	9MM	15351
9MM Makarov	Custom	#13	9.3MM	15362
351 Winchester S.L.	D	#5	N.A.	N.A.
357 Bobcat	Custom	#19	35 Cal.	15354
357 SIG	C	#5		
357 Auto Mag	Custom	#1		
357/44 Bain & Davis	Custom	#19		
38 Smith & Wesson	D	#12		
38/45 ACP	Custom	#1		
38 Special	A	#12		
357 Magnum	A	#12		
38 Spec./357 Magnum	A	#12		
357 Maximum	Custom	#12	35 Cal.	15354
375 Winchester	C	#2	375 Cal.	15371
375 Super Mag	Custom	#2		
38-55 Winchester & Ballard	C	#2		
38-56 Winchester	D	#18		
38-72 Winchester	Custom	#8	375 Cal.	15371
41 Long Colt	C	#12 or #1	N.A.	N.A.
40 Smith & Wesson	A	#5	10MM	15396
10MM Auto	A	#5		
400 COR-BON	Custom	#1		
40 Super	D	#1		
40 S & W/10MM Auto	A	#5		
10MM Centaur	Custom	#1		
38-40 Winchester	C	#9	10MM	15396
40-70 Sharps (Straight) *	Custom	#8	40 Cal.	15400
40-65 Winchester	C	#18		
40-82 Winchester	D	#18		
401 Winchester S.L.	D	#1		
40-50 Sharps Straight *	Custom	#8		
40-50 Sharps Bottleneck *	Custom	#18		
40-70 Govt (Sharps BN2.1") *	Custom	#18		
40-70 Sharps Bottleneck *	Custom	#18		
40-90 Sharps Bottleneck *	Custom	#18	40 Cal.	15400
405 Winchester	D	#8	41 Cal.	15406
41 Magnum	B	#21		
41 Action Express	Custom	#13		
414 Super Mag	Custom	#21	41 Cal.	15406
44 Russian	Custom	#19	44 Cal.	15426
44 Special	A	#19		
44 Magnum	A	#19		
44 Spec./44 Mag	A	#19		
445 Super Mag	Custom	#19		
44-40 Winchester	A	#9		
444 Marlin	C	#19	44 Cal.	15426
11MM Mauser (11.15 x 60R)	Custom	#16	N.A.	N.A.
45 GAP	—	#1	45 Cal.	15447
45 ACP & AR	A	#1 & #17		
45 Winchester Mag	Custom	#7		
45 S&W Schofield	Custom	#23		
45 Colt/454 Casull	A	#23		
450 Marlin	C	#6		
455 Webley	Custom	#6		
460 S&W Magnum	B	#23	45 Cal.	15447
45-60 Winchester	D	#18 or #26	458 Cal.	15454
45-70 U.S. Govt.	B	#18		
45-90 Winchester (Sharps)	D	#18		
458 x 2" American	Custom	#6		
458 Winchester Mag	B	#6		
458 Lott	D	#6		
45-100 Sharps (Straight) *	Custom	#18		
45-110 Sharps (Straight) *	Custom	#18		
45-120 Sharps (Straight) *	Custom	#18	458 Cal.	15454
470 Capstick *	Custom	#6	475 Cal.	15471
480 Ruger/475 Linebaugh	D	#18	475 Cal.	15471
500 S&W Magnum	B	#15	50 Cal.	15496

* Special Price Group
• Available in Bushing Dies only

Popular Case Forming Dies

Case forming dies are made on a custom basis for those who wish to form brass cases from one caliber to another. Most case forming is done to produce ammunition that is not factory available. All wildcat cartridges and many obsolete calibers fall into this category. Case forming dies are designed to change the shape of the original parent case in small increments to avoid overworking the brass and to prolong case life. After using the proper form dies and/or Form & Trim Die, full length resizing is required.

Below are a few examples of commonly formed cartridges listed with their parent case and the forming dies that are required. We make many others and they all come with complete, easy to follow instructions. If you need to form a caliber that is not listed, simply write us or call explaining what you would like to do.

NOTE: Full length resizing is a necessary final operation after all case forming to insure proper chambering.

Part No.		Price
17 Remington From 222 Rem Mag or 204 Ruger		
90217	17 Remington Form #1	\$ 93.25
83217	17 Remington Form & Trim Die	64.55
17 Ackley Hornet From 22 Hornet		
90500	17 Ackley Hornet Form #1	93.25
83500	17 Ackley Form & Trim Die	115.55
11514	Extended Shellholder #14E	23.40
17 Ackley Bee From 218 Bee		
90508	17 Ackley Bee Form #1	93.25
83508	17 Ackley Bee Form & Trim Die	115.55
11503	Extended Shellholder #3E	23.40
17 Mach IV & 17 Rem Fireball From 221 Remington		
90504	17 Mach IV Form #1	93.25
83504	17 Mach IV Form & Trim Die	89.00
11510	Extended Shellholder #10E	23.40
221 Remington From 222 or 223 Remington		
90101	221 Remington Form #1	93.25
83101	221 Remington Form & Trim Die	47.70
11510	Extended Shellholder #10E	23.40
22 Remington Jet From 357 Magnum		
90304	22 Remington Jet Form #1	93.25
94304	22 Remington Jet Form #2	93.25
83304	22 Remington Jet Form & Trim Die	115.55
11512	Extended Shellholder #12E	23.40
5.7MM Johnson From 30 M1 Carbine		
90401	5.7MM Johnson Form #1	93.25
83401	5.7MM Johnson Form & Trim Die	115.55
11522	Extended Shellholder #22E	23.40
219 Zipper From 30-30 Winchester		
90360	219 Zipper Form #1	93.25
94360	219 Zipper Form #2	93.25
83360	219 Zipper Form & Trim Die	80.55
219 Donaldson Wasp From 30-30 Winchester		
90403	219 Donaldson Wasp Form #1	93.25
94403	219 Donaldson Wasp Form #2	93.25
83403	219 Donaldson Wasp Form & Trim Die	89.00
22 Savage H.P. From 30-30 Winchester		
90338	22 Savage H.P. Form #1	93.25
83338	22 Savage H.P. Form & Trim Die	89.00
6MM PPC From 7.62MM x 39		
90319	6MM PPC Form #1 Die	93.25
83319	6MM PPC Form & Trim Die	64.55
11512	Extended Shellholder #12E	23.40
6MM B.R. Remington From 7MM B.R. Remington		
90565	6.5MM B.R. Remington Form #1	93.25
83317	6MM B.R. Remington Form & Trim Die	64.55
11501	Extended Shellholder #1E	23.40
6MM/284 Winchester From 284 Winchester		
90414	6MM/284 Winchester Form #1	93.25
83414	6MM/284 Winchester Form & Trim Die	80.55
256 Winchester Magnum From 357 Magnum		
90233	256 Winchester Magnum Form #1	93.25
94233	256 Winchester Magnum Form #2	93.25
83233	256 Winchester Magnum Form & Trim Die	64.55
11512	Extended Shellholder #12E	23.40
25 Remington From 30 Remington		
90325	25 Remington Form #1	93.25
83325	25 Remington Form & Trim Die	89.00

Part No.		Price
257 Roberts Imp 40° From 257 Roberts		
No Forming Dies Required – Fireform In The Improved Chamber		
25-35 Winchester From 30-30 Winchester		
90221	25-35 Winchester Form #1	\$ 93.25
83221	25-35 Winchester Form & Trim Die	89.00
6.5MM Rem Mag From 7MM Rem Mag or 338 Win Mag		
83266	350 Rem Mag Form & Trim Die	64.55
90231	6.5MM Rem Mag Form #1	93.25
83231	6.5MM Rem Mag Form & Trim Die	89.00
7MM IHMSA From 300 Savage		
90240	7MM IHMSA Form #1	93.25
7MM TCU From 223 Remington		
No Forming Dies Required - Use		
91242	F.L. Sizing Die W/Tapered Expander	102.95
7MM STW From 8MM Remington Magnum		
83544	7MM STW Form & Trim Die	64.55
7.65MM x 53 Mauser From 30-06 Springfield		
83243	7.65MM x 53 Mauser Form & Trim Die	89.00
7.7MM x 58 Japanese From 30-06 Springfield		
83244	7.7MM x 58 Japanese Form & Trim Die	89.00
30 Herrett From 30-30 Winchester		
83274	30 Herrett Form & Trim Die	115.55
30/378 Weatherby Mag From 378 Weatherby Mag		
90547	30/378 Weatherby Mag Form #1	93.25
83547	30/378 Weatherby Mag Form & Trim Die	80.55
300/221 Remington From 223 Remington		
83432	300/221 Remington Form & Trim Die	89.00
11510	Extended Shellholder #10E	23.40
32 Remington From 30 Remington		
No Forming Dies Required - Use		
91332	F.L. Sizing Die W/Tapered Expander	91.25
33 Winchester From 45-70 Govt.		
90205	33 Winchester Form #1	93.25
83205	33 Winchester Form & Trim Die	89.00
357 Herrett From 30-30 Winchester		
83267	357 Herrett Form & Trim Die	115.55
350 Remington Mag From 338 Winchester Mag		
83266	350 Remington Mag Form & Trim Die	64.55
356 Winchester From 444 Marlin		
83227	358 Win/356 Win Form & Trim Die	64.55
358 Winchester From 308 Winchester		
No Forming Dies Required - Use		
91227	F.L. Sizing Die w/Tapered Expander	71.70
35 Whelen From 30-06 Springfield		
No Forming Dies Required - Use		
91215	F.L. Sizing Die W/Tapered Expander	71.70
38-56 Winchester From 45-70 Govt.		
90463	38-56 Winchester Form # 1	93.25
83463	38-56 Winchester Form & Trim Die	89.00
40-65 Winchester From 45-70 Govt.		
83465	40-65 Winchester Form & Trim Die	80.55
40-70 Govt. From 45-70 Govt.		
83805	40-70 Govt. Form & Trim Die	115.55

Model No. 2 Powder & Bullet Scale



The Redding Model No. 2 Powder & Bullet Scale has been designed and manufactured with the utmost attention to accuracy and sensitivity standards. All Redding scales are individually hand calibrated, tested and adjusted to U.S. Bureau of Standards Approved Master Weights, and guaranteed accurate to less than 1/10 grain!

The Model 2 scale includes a magnetically dampened beam swing for extra fast readings. Hardened and ground knife edges ride in precision milled stainless steel bearing seats that will not crack, chip or lose their alignment.

Its pour spout pan and flat pan platform provide the convenience of an electronic scale with the accuracy and sensitivity of a laboratory beam scale.

ITEM NO. 02000 Master Powder and Bullet Scale . . . \$146.50

Features and Advantages:

- Lifetime Guarantee.
- Magnetically dampened beam.
- 505 grain capacity
- 1/10 grain accuracy.
- Convenient pour spout pan.
- Simple two counterpoise system.
- 1/10 grain over/under graduations.
- More confidence than with electronic scales.
- Better long-term sensitivity and accuracy.
- No reading drift due to temperature, battery or other conditions.
- Quicker start - no warm up.
- No batteries or electronics to fail.

*The graduated plate at the beam pointer is marked in 1/10 grain increments for easy reading of over or under charges. This eliminates the need to move the counterpoises to check powder charge variations — **you know the exact weight!** All other so-called reloading scales on the market today have only a zero or meaningless marks if any at all.*



We invite you to test the Redding Model 2 Scale!

Put it side by side with any competition regardless of price. Using tweezers, drop one or two granules of powder into the pan and watch the scale beam pointer react, then do the same with our competition. Next, zero the scale properly and move the small 1/10 grain counterpoise 3/10 grain. Watch the scale beam pointer move to an indication of -3/10 grain. Try this with any of our competition.

Model No. 5 Powder Trickler

Turn the knob and you add powder to the scale pan a granule or two at a time. Brings underweight charges up to accurate readings fast. Solid, stable, low center of gravity.

A full pound of solid steel – it won't squirm all over your bench! Ideal height for most powder scales.

NO. 05000 . . . \$38.25



Time proven accuracy and reliability

The "Classic" Model 3 Powder Measure

The **Original Classic Model 3**, time proven for accuracy and reliability. It has a micrometer metering chamber right in front for easy setting and reading. The micrometer makes it possible to record your favorite settings and return to the same place weeks later when you wish to create the same load.

Precision machined cast iron frame to give you years of service.

All Redding Powder Measures feature hand honed frames and hard chromium drums for long life. An extremely sharp cutting surface easily cuts and meters even the most difficult powders.

ITEM NO. 03000 Powder Measure with Universal Metering Chamber, Charging range approx. 5 to 100 grains **\$218.65**

ITEM NO. 03200 Powder Measure Model 3K, Includes both Metering Chambers **\$264.95**

ITEM NO. 03313 Handgun Metering Chamber (Fits only Model 3 Measures) Charging range approx. 0 to 10 grains **\$59.80**

IMPORTANT
Redding Powder Measures Are Not Intended For Use With Black Powder!

Features:

- Cast mounting bracket included with all Redding Powder Measures.
- Clear powder reservoir.
- Clear "See thru" drop tube accepts all calibers from .22 thru .45 cal.
- Body has standard 7/8"-14 thread to fit mounting bracket and optional bench stand with locking ring for fast dumping.



Competition LR-1000 Long Range Powder Measure

The popularity of large capacity cartridges like the 338 Lapua Mag. and others have pushed standard powder measures to their limits. Redding has responded by using over 40 years of benchrest experience to develop a dedicated measure for the long range precision shooter.

ITEM NO. 03800 LR-1000 Powder Measure \$326.30

Competition LR-1000 features

- Dedicated large capacity – approx. 25-140 grains.
- Anti-Backlash micrometer provides repeatable settings.
- "See thru" drop tube – accepts .30 to .45 cal.
- Accepts .22 thru .30 cal with **included** #03814 adapter.
- Extra capacity powder reservoir with adjustable baffle.
- Special operating handle – can be configured for up or down stroke, right or left operation.

ITEM NO. 03814 Drop Tube Adapter . . . \$13.95
.22 thru .30 caliber for LR-1000 Powder Measure.
Simple slip-fit over existing drop tube.

ITEM NO. 03815 Drop Tube Adapter . . . \$13.95
.50 caliber for LR-1000 Powder Measure
Simple slip-fit over existing drop tube.

Benchrest proven hemispherical metering chamber cavity.





Our most versatile powder measure... Competition proven with a broad range of charging capacity.

The Competition style operating handle is supplied with all Model 3BR powder measures

There are no aluminum parts to wear out in a Redding Powder Measure!

Match-Grade Model 3BR Powder Measure

The Match-Grade Model 3BR was created to be the ultimate powder measure... "out of the box" match ready! Since its creation this powder measure has been helping Silhouette shooters and Benchrest shooters win matches and set new records.

It all started with the time proven accuracy and reliability of the original Model 3 Powder Measure. The Model 3BR Powder Measure utilizes all of the features of the original Model 3 and to that we added the conversion features that Benchrest shooters were looking for.

It quickly became our most popular powder measure for two very good reasons . . . Its broad range of charging capacity and its performance record.

ITEM NO. 03500 Match-Grade Powder Measure 3BR
with Universal Chamber, Charging range approx.
5 to 100 grains **\$276.80**

ITEM NO. 03700 Match-Grade Powder Measure 3BRK
Includes both metering chambers **\$339.95**

IMPORTANT
Redding Powder Measures Are Not Intended For Use With Black Powder!



ITEM NO. 03817 Drop Tube Adapter
Fits all Redding Powder Measures and Funnels with a Simple slip-fit.
For .17 & .20 caliber **\$13.95**

Competition Proven Conversion Features...

Now used on the Match-Grade Model 3BR and both Competition Powder Measures, the Model BR-30 and 10X Pistol/Small Rifle.



ITEM NO. 03331 Handgun Metering Chamber
(Fits only 3BR Measures) Charging range approx. 0 to 10 grains **\$ 79.25**



ITEM NO. 03330 Universal Metering Chamber
(Fits only 3BR Measures) Charging range approx. 5 to 100 grains **\$ 79.25**

ITEM NO. 03018 Powder Measure Mounting Bracket
(shelf bracket fits all Redding powder measures).
. **\$ 25.50**



ADJUSTABLE POWDER BAFFLE

To create exceptional uniformity from charge to charge we have placed an adjustable powder baffle above the metering chamber. This maintains a constant amount of powder above the metering chamber regardless of the level of powder in the reservoir.

POSITIVE LOCK

When the micrometer adjustment lock screw (opposite side) is loosened to change settings, the micrometer body cannot move, since the micrometer is held in place by a separate lock screw. In a measure this precise, there is no room for error and nothing can be left to chance.



PRECISION MICROMETER

A special micrometer is used in all Match-Grade and Competition Powder Measures that eliminates backlash in the screw threads. Your settings will be fast, accurate and exactly repeatable.

Designed specifically for Benchrest Competition.

Competition Model BR-30 Powder Measure

The Competition Model BR-30 Powder Measure is truly a competition model with some very special features. One of these features (the drum and micrometer) limits the overall charging range from a low of 10 grains (dependent upon powder density) to a maximum of approximately 50 grains.

As a result we do not expect this model to be the proper choice for everyone. If, however, you are a serious competitive shooter and your loading requirements are generally between 10 and 50 grains, this is certainly the measure to choose.

This measure uses all of the competition proven features of the Match-Grade Model 3BR. To achieve the most uniform powder metering possible for Benchrest Competition, at a targeted charge weight of approximately 30 grains, (hence the name BR-30) an entirely new drum and metering unit was created. The diameter of the metering cavity was reduced and the metering plunger was given a unique hemispherical or "cup" shape. This shape creates a powder cavity that resembles the bottom of a test tube to alleviate irregular powder settling and to enhance charge to charge uniformity.

A special operating handle was also created for this model. It's a rotating handle, slightly heavier to help you maintain a more uniform stroke.

ITEM NO. 03300 Competition Model BR-30 Powder Measure \$326.30

New! **ITEM NO. 03818 Drop Tube Extension**
4-1/2" extension fits all Redding Powder Measures and Funnels. Simple slip-fit over existing drop tube. For .22 thru .30 calibers **\$20.75**

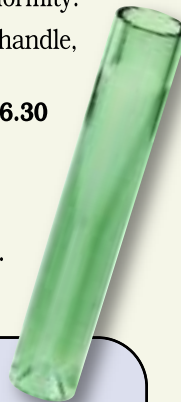

— 17 Hornet News —

The Competition Model 10X Powder Measure was designed for the optimum charge weight of the new 17 Hornet. Simply add the No. 03817 Drop Tube Adapter, shown on the opposite page, for direct charging.

Designed specifically for handgun and small capacity rifle cartridges.

Competition Model 10X Pistol & Small Rifle Powder Measure

This powder measure uses all of the special features of the Competition Model BR-30 combined with an entirely new drum and metering unit designed to provide the most uniform metering of small charge weights.

To achieve the best metering possible at the targeted charge weight of approximately 10 grains, the diameter of the metering cavity was reduced and the metering plunger was given the unique hemispherical cup shape of our successful Model BR-30. The result is a very specialized small capacity powder measure with a charge weight range of approximately 1 to 25 grains.

ITEM NO. 03400 Competition Model 10X Powder Measure \$326.30



**Shown with
Optional
Bench Stand
and Clamp
...see page 41**

**IMPORTANT
Redding Powder
Measures Are
Not Intended
For Use With
Black Powder!**

The T-7 combines strength, power and convenience with the speed and versatility of a turret press.

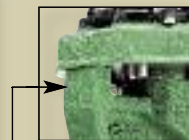

Rear casting support assures a rigid turret and precise alignment.



Shown with optional "Slide Bar Automatic Primer Feeder System".

Features:

- Seven station turret head with operating handle
- Heavy duty cast iron frame for strength and wear resistance
- Powerful compound linkage with positive ram stop.
- 1" diameter ram
- 4-3/4" press opening
- 3-13/16" ram stroke
- Ball handle
- "Spent primer collection system"
- Accepts all standard 7/8"-14 threaded dies and universal shell holders
- Shellholders may be rotated to any comfortable position desired
- "Smart" primer arm for seating small and large primers
- Interchangeable turret heads
- Competition die compatible

"Cast iron construction, powerful compound linkage and a rigid seven station turret combine to make the Redding T-7 the best turret press ever!"

The T-7 Turret Reloading Press

The design criteria was to create the ultimate turret press. Our engineering team started with our time proven cast iron construction and turret support that is second to none. They added powerful compound linkage with over 3.8" of ram travel. A 1" diameter hollow ram was chosen with the "smart primer arm" and "spent primer collection system" borrowed from our Ultramag. Another station was added to the turret for even greater versatility and an optional "Slide Bar Automatic Primer Feeding System" was designed.

After adding a few more subtle refinements and built with the precision you would expect from Redding, we're confident this is the best turret press ever.

Shown with optional "Slide Bar Automatic Primer Feeder System". Also fits the new Big Boss Press. See below for details.

ITEM NO. 67000 \$513.70

Buy the Kit, Save 25% on Dies and Shellholder

Also available in kit form: Includes press, shellholder, and your choice of any Series "A" full length die set. ITEM NO. 67XXX \$583.75

For Order No., replace XXX with the last three numbers from the Series "A" dies, see chart on page 11.

Optional Slide Bar Automatic Primer Feeding System

Eliminates handling of primers, and speeds-up reloading operations. Comes complete with individualized tubes for both large and small primers. Capacity: approximately 100 primers. Fits the T-7 and Big Boss Presses.

ITEM NO. 99600 \$75.40



Extra Slide Bar Primer Arm Assembly

This item allows you to quickly change primer cup & pin sizes by simply replacing the slide bar assembly on your Automatic Primer Feeder. Includes slide bar, knob, spring and large & small primer cup assemblies.

ITEM NO. 99585 \$27.80



These top of the line single station presses have the largest window opening and longest usable ram stroke of any in their class.

The Big Boss II and original Big Boss Reloading Presses

Both the original Big Boss and the new Big Boss II reloading presses have all the desirable features of the "Boss" reloading press, but are built on heavier frames with a 1" diameter ram and longer 3.8" usable ram stroke for reloading the largest magnum cartridges.

The Big Boss II now features the unique Redding "Spent Primer Collection System" used on the T-7 and Ultramag presses. This top of the line single station press has the largest window opening and longest usable ram stroke of any press in its class. Simply, the only press you will ever need!

ITEM NO. 97000 Big Boss II \$329.50

ITEM NO. 79000 Big Boss \$295.60
(Original Big Boss Press is supplied with "Boss" style primer catcher.)

ITEM NO. 97601 Big Boss II ram only . . \$58.25

Buy the Kit, Save  25% on Dies and Shellholder

Also available in kit form: Includes press, shellholder, and your choice of any Series "A" full length die set.

ITEM NO. 97XXX Big Boss II \$399.65

ITEM NO. 79XXX Big Boss \$365.70

For Order No., replace XXX with the last three numbers from the Series "A" dies. see chart on page 11.

Optional bushing for 1"-14 threaded dies

ITEM NO. 70030. \$27.80

"Spent Primer Collection System"

Spent primers automatically drop through the large diameter hollow ram into a handy flexible plastic tube that can hold hundreds of spent primers before emptying, or be easily routed to your trash container.



"Smart Primer Arm"

"Smart" primer arm automatically swings into position during the ram stroke and flips out of the way when not in use. For maximum sensitivity at the lowest possible leverage, priming is done at the end of the ram stroke.



The Big Boss II –
Now featuring the unique Redding
"Spent Primer Collection System"
used on the T-7 and Ultramag presses.

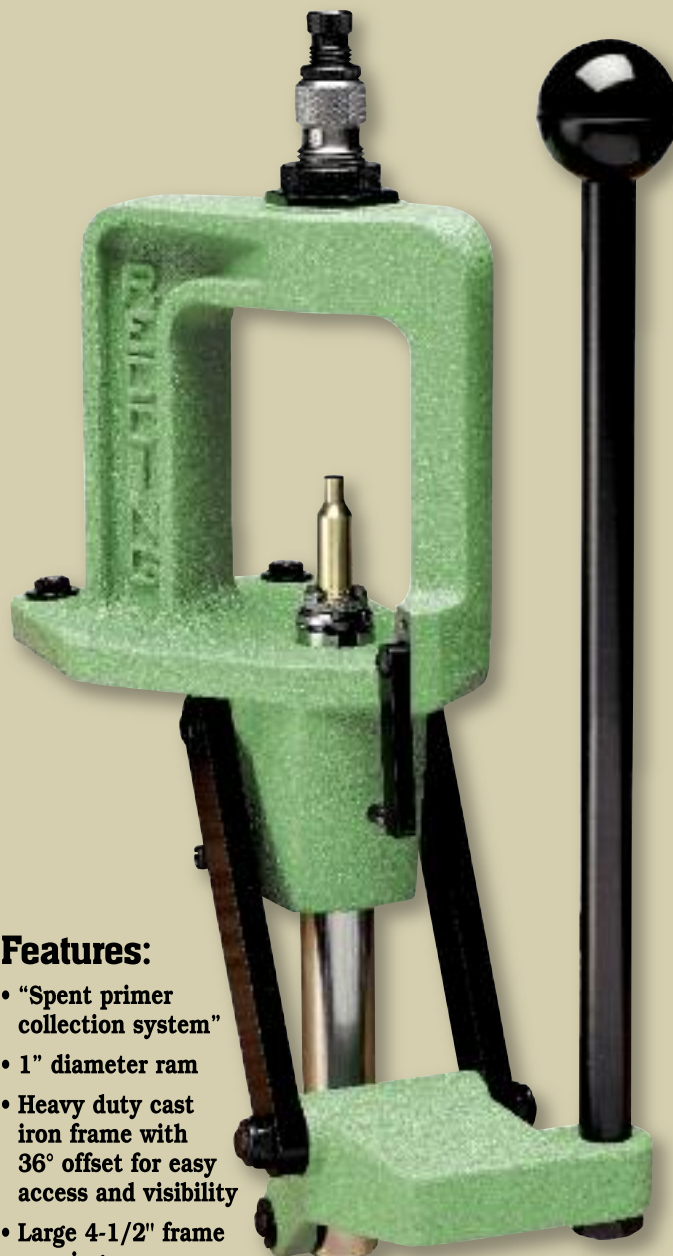

Features:

- "Spent primer collection system"
- 1" diameter ram
- Heavy duty cast iron frame with 36° offset for easy access and visibility
- Large 4-1/2" frame opening
- 3-13/16" of ram stroke for easy reloading of magnum cartridges
- Offset/straight pull ball handle for ease of operation
- "Smart" primer arm that moves in and out of position with ram travel
- Heavy duty compound linkage
- Steel adapter bushing accepts all standard 7/8"-14 threaded dies and is removable for use with oversized dies
- Frame with bushing removed accepts 1-1/4" - 12 dies

**The Quality of Cast Iron at
The Price of Aluminum!**

The Boss Reloading Press

Here is the press that has all the features reloaders look for. It's cast iron construction insures that it will last a lifetime, yet it is priced with light-duty aluminum presses! The BOSS is powerful, remarkably easy to use, and yet sensitive enough to seat primers without crushing them.

Take a look at all the features The BOSS offers and you'll be convinced...when it comes to "O" Type reloading presses, this one is truly a smart choice.

ITEM NO. 72100 \$234.25

Buy the Kit, Save  on Dies and Shellholder

Also available in kit form: Includes press, shellholder, and your choice of any Series "A" full length die set.

ITEM NO. 72XXX \$304.30

For Order No., replace XXX with the last three numbers from the Series "A" dies, see chart on page 11.

"My accomplishments with Redding products" — Charles Ballard

Features:

- Rigid cast iron frame
- 36° frame offset gives the best visibility and access of all comparable presses
- "Smart" primer arm automatically moves in and out of position with ram travel. Priming arm is positioned where it should be...at the bottom of ram travel for the lowest leverage and best feel
- Offset handle is in the most comfortable operating position yet out of the way for best access and visibility
- Positive ram travel stop
- Powerful compound linkage
- 3 holes for rigid mounting
- Accepts all standard 7/8"-14 threaded dies and universal shellholders
- Shellholders may be rotated to any comfortable position desired
- Includes primer catcher



- Aug. 2007 Set National Record-F-Class Open 15 shot 600 yards 149-7x (300WSM)
- Aug. 2007 Set National Record-F-Class Open 15 shot 1000 yards 148-4x (300WSM)
- Won 2008 North Carolina F-Class State Championship
- Won 2008 NRA Long Range Regional Championship (F-Open Div.)
- June 2008 Set World Record F-Class Open 20 shot 1000 yards 200-13x
- Won 2008 NRA United States F-Class National Championship
- Oct. 2008 Set National Record F-Class National Championship Grand Aggregate Score 1337-65x
- Won 2009 NRA Long Range Regional Championship (F-Open Div.)

- Won 2009 Spirit of America- Fullbore National Championship (F-Open Div.)
- Won 2009 North Carolina State F-Class Championship
- Won 2009 US F-Class National Championship



Ball Handle Conversion

Convenient, easy-to-attach conversion for those who prefer a ball handle on their reloading press. Fits the Redding BOSS and other reloading presses that use a 5/8" handle diameter. Easily attaches without machining or threading.

ITEM NO. 99175 \$11.95

“The largest and strongest press available for the toughest reloading chores...”

(HANDLOADER Magazine, No. 148)

The Ultramag Reloading Press

At first glance you will see what sets the ULTRAMAG apart from all other reloading presses: the unique location of its compound leverage system. Unlike other reloading presses which connect the linkage to the lower half of the press, the ULTRAMAG'S leverage system is connected to the top of the press frame. This allows you to develop literally tons of pressure without the usual concern about press frame deflection or misalignment.

The ULTRAMAG features a huge 4-3/4" frame opening and 4-1/8" of usable ram stroke, making it ideal for loading oversized cartridges such as the old Sharps "Buffalo Cartridges" and British "Nitro-Express" rounds.

Its unique long link compound leverage system has more mechanical advantage over a greater distance than any other reloading press on the market. This makes "childs play" of difficult case forming operations.

ITEM NO. 70000 \$533.25

Buy the Kit, Save  25% on Dies and Shellholder

Also available in kit form: Includes press, shellholder, and your choice of any Series "A" full length die set.

ITEM NO. 70XXX \$603.25

For Order No., replace XXX with the last three numbers from the Series "A" dies, see chart on page 11.

• Optional bushing for 1" - 14 die threads is also available.

ITEM NO. 70030 \$27.80



“Smart Primer Arm”

“Smart” primer arm automatically swings into position during the ram stroke and flips out of the way when not in use. For maximum sensitivity at the lowest possible leverage, priming is done at the end of the ram stroke.



“Spent Primer Collection System”

Spent primers are automatically collected in the large diameter hollow ram. They then drop into a handy flexible plastic tube that can hold hundreds of spent primers before emptying, or be easily routed to your trash container.



Features:

- The frame is constructed of high grade cast iron for strength, long life and wear resistance
- Four mounting holes provide rigid mounting
- Offset handle is out of the way for all reloading operations
- All linkage pins are heat treated, precision ground and in double shear
- Steel adapter bushing accepts standard 7/8"-14 threaded dies and is removable for use with oversized dies
- Frame with bushing removed accepts 1-1/4" - 12 die threads
- "Smart" primer arm that moves in and out of position with ram travel
- "Spent primer collection system"

Model 2400 Match Precision Case Trimming Lathe

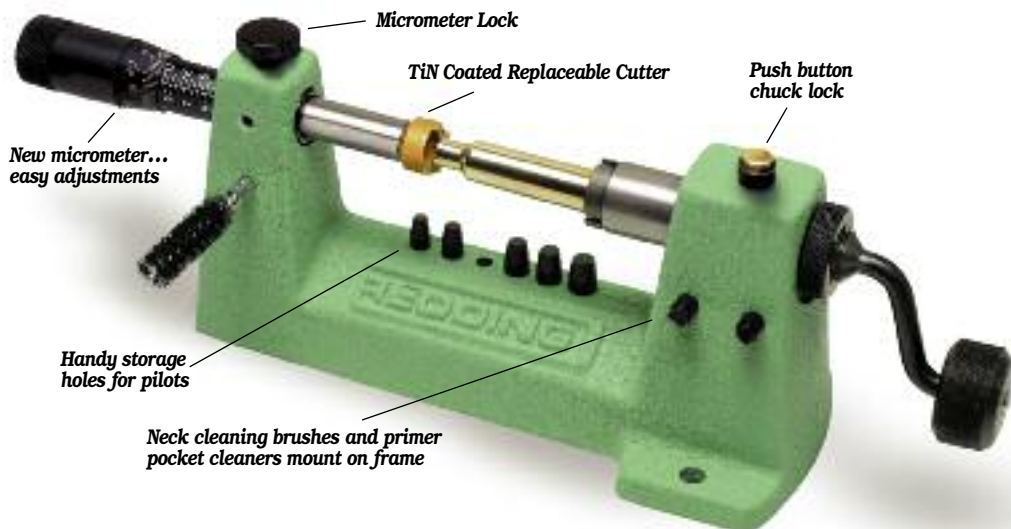

The most noteworthy feature of the Model #2400 Case Trimming Lathe is the new Micrometer which adds precision and repeatability to the case length adjustment. Changes as little as .001" can be easily "dialed in".

The innovative new push button chuck lock simplifies loading and unloading while facilitating perfect alignment of the case and pilot. The design of the new push button chuck lock, combined with the extended cast iron frame of the Model #1400-XT, increases case length capacity; accommodating not only the latest long action cartridges but old time classics as well.

ITEM NO. 24000 \$286.50

Model 2400 features:

- New micrometer...easy adjustments of .001".
- Cast iron frame to maintain precision alignment.
- New push button collet chuck is ideally suited for use with optional power adapter.
- Handles 17 to 50 Cal, up to 3-1/4" case length.
- Universal collet fits all popular cases – no others to buy.
- TiN (Titanium Nitride) coated replaceable cutter.
- Storage holes for pilots.

Model 1400-XT Case Trimming Lathe

The Model #1400-XT Case Trimming Lathe uses a cast iron frame that has been extended to handle all the latest long action cartridges. The frame is cast iron because it is a perfect bearing surface, will not wear out and will maintain its precision and alignment for years of service.



ITEM NO. 14000 \$ 165.25



"The New 2400 Case Trimming Lathe is another "Home-Run" for Redding. Your equipment is very well thought out."

Rich Maretzo - Precision Shooting Inc.

Redding "case trimming lathes" are the only case trimmers on the market that turn the case and not the cutter. This feature guarantees a perfectly square case mouth with every cut.

Both the Model #1400-XT and the #2400 Case Trimming Lathes are supplied with the following:

- Universal collet fits all popular cases.
- TiN (Titanium Nitride) coated replaceable cutter.
- Six pilots - .22 cal., 6mm, .25 cal., .270 cal., 7mm and .30 cal.
- Two neck cleaning brushes (.22 thru .30 cal.)
- Large and small primer pocket cleaners.

Model 1400-XT features:

- Cast iron frame to last a lifetime.
- Universal collet fits all popular cases - no others to buy.
- Handles 17 to 50 Cal, up to 3" case length.
- TiN (Titanium Nitride) coated replaceable cutter.
- Coarse and fine adjustments for case length.
- Storage holes for pilots.



3/16" Shank Pilots may also be used on Hornady and Forster trimmers.



Universal Collet accepts all popular cases – no others to buy!



New replaceable (TiN) Titanium Nitride coated high speed cutters.



Optional Power Adapter with 1/4" hex for use with cordless screwdrivers. Works with both trimmers.

ITEM NO. #14025 . . . \$19.40

ITEM NO. 14040 TiN Cutter (17 & 20 caliber)* . . \$ 36.25

ITEM NO. 14045 TiN Cutter & Shaft Complete . . 45.90

ITEM NO. 14050 TiN Cutter (Standard) 36.25

ITEM NO. 15XXX Pilots \$ 7.55

ITEM NO. 99301 Special Collet for 470 Nitro . . 26.80

Refer to die reference chart on pages 20, 21 & 22 for pilot number.

Item No. 14045 assembly fits only Model 14 & 1400 Trimmers. The Model 2400 micrometer will not fit any other Trimmer.

Possibly one of the most important tools you will ever use!

Case Neck Gauge

Provides a quick and easy way to sort cases by neck wall thickness and uniformity. This tool allows you to accurately measure the neck wall thickness of the cartridge case and determine its uniformity, (see below Tech-Talk – Case Neck Uniformity.)

Two mandrel sizes are supplied to allow measurement of all cases from .17 cal. to .338 cal. including cases with small (.060) flash holes. For your convenience the mounting base allows direct attachment to your reloading bench, or use the Redding No. 30520 double “C” clamp (see page 41).

Pilot stops are required for each caliber (see chart below). Two pilot stops are supplied with the tool, #06121, .22 cal. and #06130, .30 cal.

ITEM NO. 26400 Case Neck Gauge complete w/large 1” x .001” dial indicator \$149.75



– Tech Talk – Case Neck Uniformity

Uniformity of case neck wall thickness is an indication of the quality of the cartridge case itself. Any large variation (over .0015”) in neck wall thickness will generally indicate a similar or greater variation in the body and shoulder of the case. This variation cannot be corrected and may lead to concentricity and bullet runout problems.

Most competition shooters that have been forced to turn necks to properly fit “tight neck” chambers will confirm the following: “Turning the necks of poor quality cases will not solve the problems associated with the poor uniformity that remains within the shoulder and body of the case.”

As in all handloading practices – uniformity is the key accuracy.

Primer Pocket Uniformers

Redding Primer Pocket Uniformers are precision ground carbide tools designed to cut primer pockets to a uniform depth and square to the case head.

The depth of cut is to SAAMI specifications and is controlled by a shoulder ground into the cutter that cannot change.

Available for large and small rifle primer pockets. Each cutter is supplied with an integral holder having a #8-32 threaded shank to fit the Redding #18005 accessory handle.



Unique chatterless
5 flute design

ITEM NO. 09100 Large Rifle Primer Pocket Uniformer
with accessory handle & power screwdriver adapter \$48.25

ITEM NO. 09105 Small Rifle* Primer Pocket Uniformer
with accessory handle & power screwdriver adapter \$48.25

ITEM NO. 09110 Optional – Power Screwdriver Adapter
(1/4” hex O.D. with #8-32 I.D. threads) \$5.25

***Note: Small Rifle Primer Pocket Uniformer is dimensionally correct for small pistol. Do not use the Large Rifle Primer Pocket Uniformer for Large Pistol.**

Flash Hole Deburring Tools

During the manufacturing process, burrs that can cause erratic ignition are often left inside the case at the flash hole.

Redding now manufactures two different tools for removal of flash hole burrs. Both tools use pilot stops listed below.

The universal tool is for all calibers from .22 thru .338 cal. using standard (.080”) flash holes. This tool controls the cutting depth with a built-in stop that locates on the inside web of the case. A unique feature of this tool is the cross drilled hole for chip relief. Uses standard pilot stops for 3/16” mandrels.

The small tool is for .17 & .20 cal. and cases with small (.060”) flash holes. This tool *does not* control the cutting depth. The operator must control the cutting depth using the small pilot stops for 9/64” mandrels.

ITEM NO. 06100 Universal Flash Hole Deburring Tool with handle
(supplied with #06130 .30 cal. pilot stop) \$41.75

ITEM NO. 06110 Small Flash Hole Deburring Tool with handle
(supplied with #06121 .22 cal. pilot stop) \$41.75

ITEM NO. 18005 Lg. Accessory Handle with #8-32 thread . . . \$11.65

ITEM NO. 06103 Sm. Accessory Handle with #6-32 thread . . \$11.65



Stainless Pilot Stops



Precision CNC machined stainless steel for use with the new Redding Case Neck Gauge and Flash Hole Deburring Tools.

Designed to properly fit new and resized case necks, these pilot stops feature a very unique shape. Slightly undercut, this shape will not pick up imperfections at the case mouth or neck/shoulder junction resulting in smooth accurate indicator readings when used with the new Case Neck Gauge.

Two sizes are available because of the small (9/64”) mandrels used for .17 & .20 cal. and small flash holes. The larger size (for standard 3/16” mandrels) work equally well with the tools of other manufacturers.

ITEM NO.	CALIBER	ITEM NO.	CALIBER	ITEM NO.	CALIBER
06117	.17 CAL.*	06124	6MM	06128	7MM
06120	.20 CAL.*	06125	.25 CAL.	06130	.30 CAL.
06121	.22 CAL.*	06126	6.5MM	06131	.31 CAL.
06122	.22 CAL.	06129	6.5MM*	06132	8MM
06123	6MM*	06127	.270 CAL.	06133	.338 CAL.

* Pilots for small diameter 9/64” mandrels

ITEM NO. 061XX Stainless Pilot Stop \$12.25 ea.

Pro-Pak Reloading Kits

“An Investment in Quality Tools.”

We've selected our best reloading components and put them into one neat, money-saving package. This kit was created for both the first-time reloader to get started right and for the more advanced reloader desiring to upgrade his equipment.

The Boss and Big Boss Pro-Paks contain the following:

- The Boss or Big Boss Reloading Press – Our best selling presses.
- Model 2 Powder and Bullet Scale. Simply the most sensitive, most accurate scale on the market.
- Powder Trickler – Heavy stable companion to the powder scale.
- Pad Style Case Lube Kit – Consists of our non-skid lube pad and our Imperial Bio-Green case lube.
- Deburring Tool – The cutting edges are ground correctly for clean chatterless cuts.
- Model 18 Case Preparation Kit – Plastic accessory handle with all the tools and brushes you need to properly clean your fired cases before resizing.
- Powder Funnel – Made of tough Lexan® and nearly indestructible.
- Hodgdon Annual Manual – Reloading information for rifle and pistol ammo using Hodgdon, IMR & W-W powders in addition to a variety of helpful handloading articles.



BOSS PRO-PAK	
NO. 20000 \$522.25
BIG BOSS PRO-PAK	
NO. 40000 580.40
BIG BOSS II PRO-PAK	
NO. 57000 613.85

Reloading DVD

Advanced Handloading – Beyond The Basics

A perfect companion to your new Redding Reloading Equipment, this DVD guides you through the advanced techniques needed to improve the accuracy of your ammunition and is hosted by, noted handloading author, John Barsness.

ITEM NO. 05978 \$20.35



Versa Pak & Versa Pak Pro

Advanced Reloading Kits



“Whether your goals include record books or record bucks, the best ammunition in the world comes from your hands and our tools.”

The Versa Pak

As the name implies the Versa Pak was created for versatility, offering all of the products a serious handloader needs, (without the press and dies), at a substantial savings over the cost of the individual items. This allows the first time or seasoned handloader to improve his or her experience with, not just the best equipment but equipment best suited to his or her individual needs. The Versa Pak includes all the items listed in the Pro Pak and our Classic Model 3 Powder Measure, a 1400 XT Case Trimmer, Imperial Dry Neck Lube in Application Media, a starter size of Imperial Sizing Die Wax and our DVD, “Advanced Handloading, Beyond the Basics”. When mated with any Redding press and dies (many available in discounted packages) you can build the right package for a lifetime of service whether you intend to load for handgun or the big Sharps rifle cases. The Versa Pak is a great entry package into the reloading activity with quality products and accessories, which will not only last a lifetime but have the features and precision to remain truly useful tools throughout your lifetime.

ITEM NO. 35000 \$666.60

The Versa Pak Pro

Previously sold only in Europe, this ultimate upgrade of the Versa Pak replaces the 1400 XT Case Trimmer with our unique Micrometer Adjustable Model 2400 Case Trimming Lathe (Page 32). It also adds the Match Grade model 3BR Powder Measure (Page 26) in place of the Classic Model 3.

ITEM NO. 35750 \$832.60

SAECO – a product of Redding Since 1985

Considered by many to be the finest lubricator/sizer available today.

SAECO Lubri-Sizer

A single stroke seats gas checks, swages bullets to proper diameter, and lubricates them. The pressurized reservoir lubricates from 20 to 50 bullets between turns of the lube control handle. Parallel guide rods assure proper alignment of the top punch and sizing die, resulting in maximum bullet concentricity.

Those who prefer to shoot bullets "as cast" will appreciate the exclusive swing out gas check seater which allows the option of seating gas checks without sizing.

A combination of compound leverage and extra length operating handle substantially reduces physical effort.

ITEM NO. 30000 \$335.25

Sizing Dies and Top Punches are not included and should be ordered according to caliber and bullet design.



SAECO Bullet Lubricants

SAECO GOLD – Pistol Lubricant

The original alox free formula developed by SAECO. Keeps barrels cleaner and reduces leading to a minimum for superior accuracy. Also makes an excellent fluxing agent and works equally well in rifles.

SAECO TRADITIONAL – Rifle Lubricant

This is the NRA formula for Alox and bees wax. We use natural yellow beeswax, not synthetics. Formulated to prevent leading and improve accuracy at higher velocity levels.

SAECO GREEN – Rifle and Pistol Lubricant

An original SAECO formula brought back. Contains no alox. Slightly harder than the other SAECO lubes.

Available in Solid or Hollow Sticks . . . \$ 10.75

Top Punches

SAECO's exclusive tapered shoulder assures positive alignment with die body. A single Top Punch may be used interchangeably with several bullets of similar design. See Mould Table for top punch number **\$26.25**



Top Punches Lyman/RCBS Type

Straight shank type top punches designed to fit the Lyman and RCBS Lubrisizers and SAECO bullets. See mould table for "LR" top punch number. **\$26.25**



SAECO Sizing Dies

SAECO sizing dies are made with a unique pre-lead that fits the "as cast" bullet diameter. This insures that bullets feed into the sizing diameter in absolute straight alignment. The dies are finished by internal honing known as micro-finishing which produces a mirror finish and a sizing hole that is perfectly round. Your bullets will look like polished silver with no lead shavings.

ITEM NO. 30XXX \$ 62.25

For order No., replace XXX with size from chart below.

DIE SIZES AVAILABLE:

.224 .225 .244 .251 .258 .265 .266 .278 .285 .286 .308 .309 .310 .311 .312 .313 .314 .321 .322 .323 .324 .325 .338 .339 .349 .354 .355 .356 .357 .358 .359 .360 .364 .365 .366 .375 .376 .377 .378 .401 .408 .409 .410 .411 .417 .427 .428 .429 .430 .431 .451 .452 .454 .455 .458 .459 .460



SAECO Lead Hardness Tester

A precision instrument to accurately determine the hardness of a bullet casting alloy.

A SAECO Lead Hardness Tester will pay for itself many times over by allowing you to convert inexpensive scrap lead of unknown composition into casting alloy of known and reproduceable hardness. It provides a standard by which you can check the quality of purchased cast bullets. The SAECO Lead Hardness Tester measures alloy hardness by determining the depth of penetration of a hardened steel indenter into a bullet. Relative hardness of the bullet is read off a vernier scale.

The vernier scale is calibrated in arbitrary units from 0 for pure lead up to a SAECO hardness of 10. We have found that a SAECO hardness of at least 6 is required for medium velocities in handguns and a SAECO hardness of over 8 for Magnum handgun and gas check rifle bullets. As a point of reference, wheelweights vary in composition and hardness but usually test between 7 and 9, while linotype registers approx. 10.



Relative Hardness	SAECO	Brinell (Approx.)
Pure lead	0-1	5
1:20 tin: lead	6-7	10
5:5:90 tin: antimony: lead	7-8	15
2:6:92 (taracorp) (magnum alloy)	8-9	16-17
5:10:85 (linotype)	9-10	22

ITEM NO. 42000 \$264.95

SAECO Precision Bullet Moulds

All SAECO moulds are machined from solid cast iron blocks one cavity at a time. Using the same cutting tool (cherrie) for each cavity on digital equipment guarantees that each cavity duplicates the previous one. You don't need to pay a premium for matched cavities. SAECO even developed its own blend of copper alloyed pearlitic cast iron for tight grain structure, dimensional stability and extended life. The steel sprue plates are held firm against the mould blocks by high-temperature spring washers to insure uniform bullets with square bases.

1 Cavity "Magnum" . \$140.00 2 Cavity "Magnum" . \$188.00 SPECIAL ORDER 3 CAVITY MOULDS
2 Cavity 157.35 4 Cavity 263.95 All 3 cavity moulds are made on a special
order basis only. . . . \$ 212.25

WARNING:
 Melting lead and casting lead objects will expose you and others in the area to lead, which is known to cause birth defects, other reproductive harm and cancer. See instructions on Reducing Exposure supplied with product.



"Magnum" Mould Blocks Available in Single and Double Cavity

"Magnum" mould blocks were created to insure more uniform temperature control and casting consistency when casting large diameter and/or heavy bullets. Single cavity "Magnum" moulds are made from our normal double cavity blocks. Double cavity "Magnum" moulds are made from our normal triple cavity blocks, with wider spacing.

"Magnum" moulds can be ordered for any caliber or weight bullet and are required for those moulds marked with asterisk*.

Mould Handles
 Castings are ductile iron with solid hardwood grips. They should be ordered separately and fit all SAECO mould blocks.
ITEM NO. 29000 . . . \$71.25

Traditional Bullet Moulds For Black Powder Cartridges & Cowboy Action Shooting

All SAECO bullet moulds must be ordered with the SAECO bullet number. Illustrations not to scale.

	30 CAL. RIFLES		32-20 WIN	32-40 WIN		38 SPL/ 357 MAG	38-40 WIN	38-55 WIN		
No.	630	315	322	632	*732	358	401	638	738	*571
Designation	140gr. FP	175gr. TCGC	118gr. RNFP	165gr. RNFP	200gr. RNFP	158gr. RNFP	190gr. RNFP	225gr. RNFP	255gr. RNFP	300gr. RNFP
Sizing Die	.309	N.R.	.313	N.R.	N.R.	.358	.401	N.R.	N.R.	N.R.
Top Punch	30530	30329	30254	30530	30530	35353	40101	37570	37570	37570
◆ LR Top Punch	46511	46509	46507	46511	46511	46518	46531	46528	46528	46528
Description	For 30-30	Bench Rest •Tapered	.32-20 Bullet	.32-40 •Tapered	.32-40 •Tapered	Super Long Range Bullet	.38-40	•Tapered	•Tapered	•Tapered
	40 CAL. RIFLES		44-40 WIN	44 SPL/44 MAG		45 COLT		45 CAL. RIFLES		
No.	*640	*740	444	446	429	954	955	*645	*745	*881
Designation	370gr.	410gr.	200gr. RNFP	200gr. RNFP	240gr. RNFP	230gr. RNFP	255gr. RNFP	480gr.	525gr.	500gr. RN
Sizing Die	.408/.410	.408/.410	.428	.430	.430	.452/.454	.452/.454	.458/.460	.458/.460	.458
Top Punch	40410	40410	44191	44191	44191	45424	45424	45525	45525	45525
◆ LR Top Punch	46532	46532	46538	46538	46538	46550	46550	46553	46553	46553
Description			.44-40	.44 Spec/Mag						M1881 Design





























































* Tapered Styled Bullets have the front band near bore diameter tapering to slightly larger than groove diameter. This style bullet was furnished by most of the old time barrel makers such as Harry Pope. This is a popular Schuetzen style bullet with rounded lube grooves.
 * Due to length, diameter or weight, the moulds indicated are available in "Magnum" mould blocks only. ◆ Designates Lyman/RCBS style Top Punches

SAECO Bullet Moulds

All SAECO bullet moulds must be ordered with the SAECO bullet number. Illustrations not to scale.

WARNING:

Melting lead and casting lead objects will expose you and others in the area to lead, which is known to cause birth defects, other reproductive harm and cancer. See instructions on Reducing Exposure supplied with product.

													
No.	221	243	257	264	270	281	070	071	073		302	254	316
Designation	60gr. SPGC	85gr. TCGC	100gr. TCGC	140gr. SPGC	140gr. TCGC	145gr. FPGC	145gr. TCGC	160gr. TCGC	165gr. SPGC		120gr. RNGC	115gr. RNBB	150gr. FPGC
Sizing Die	.225	.244	.258	.265	.278	.285	.285	.285	.285		.309	.309	.309
Top Punch	22498	24243	25258	26264	27273	28311	28520	28520	28520		30467	30467	30530
LR Top Punch	46500	46501	46502	46503	46504	46505	46506	46506	46506		46510	46510	46511
Description	Works Well in .223 Semi Autos	For all .243 & .244 Cal.	.25 Cal. Silhouette		Two perfect 60's shot at Reg. 6 IHMSA	Standard for 7mm	Silhouette	200 meters Silhouette	Heavy 7mm Bullet		For 30 MI, GC	For 30 MI	For 30-30
													
No.	311	307	301	305	323	325	326	321		081	922	925	
Designation	165gr. TCGC	180gr. FPGC	196gr. TCGC	180gr. FPGC	95gr. WC	95gr. SWC	100gr. SWCBB	95gr. RN		190gr. RNGC	115gr. RNBB	115gr. SWCBB	
Sizing Die	.309	.309	.309	.311	.313	.313	.313	.313		.323/.324	.356	.356	
Top Punch	30301	30530	30301	30530	32323	32467	32467	32465		32467	35311	35925	
LR Top Punch	46508	46511	46508	46511	46512	46514	46514	46513		46514	46516	46526	
Description			Duplicates Original RG4	303 British	.Good .32 Long Target Bullet			.32 S&W Long		8 mm Rifle			
													
No.	377	384	115	924	383	928	929	910	930		940	052	053
Designation	122gr. TCBB	122gr. RN	122gr. RNBB	124gr. SWCGC	140gr. SWC	145gr. RNBB	145gr. SWCBB	150gr. RN	154gr. SWCBB		100gr. RNBB	148gr. WCBB	148gr. WC
Sizing Die	.356	.356	.356	.356	.356/.357	.356/.357	.356/.357	.356	.356/.357		.365	.358	.358
Top Punch	35375	35311	35311	35925	35429	35311	35925	35311	35925		35465	35550	35381
LR Top Punch	46519	46516	46516	46526	46522	46516	46526	46516	46526		46524	46525	46520
Description	Good Ballistics for 9 mm	Good Feeding 9mm		Good Feeding SWC		38 Super	38 Super		38 Super Wilson Design		9mm Makarov	Target Bullet	GAR Design
													
No.	397	348	382	388	393	390	391	398	353	354	396	399	351
Designation	148gr. WCDBB	148gr. DBBWC	158gr. SWC	158gr. SWCBB	162gr. SWCGC	158gr. RN	158gr. RNBB	158gr. TC	180gr. FP	180gr. FPGC	180gr. TC	180gr. TCGC	200gr. FP
Sizing Die	.358	.358	.358	.358	.358	.358	.358	.358	.358	.358	.358	.358	.358
Top Punch	35344	35344	35429	35429	35429	35311	35311	35399	35353	35353	35399	35399	35399
LR Top Punch	46517	46517	46522	46522	46522	46516	46516	46521	46518	46518	46521	46521	46516
Description	148gr. Double Bevel Base WC	Single Groove DBB	Keith Design	Most Popular		Standard .38 Bullet			Super Long Range Bullet	GC Version of Popular 353			Heavy 357 Bullet
													
No.	356	395	352	373	040	043	045	047	048		416	419	
Designation	200gr. FPGC	200gr. TCGC	245gr. FPGC	265gr. FPGC	155gr. SWCBB	170gr. TCBB	170gr. SWCBB	200gr. TCBB	200gr. SWCBB		170gr. SWCBB	200gr. SWCBB	
Sizing Die	.358	.358	.358	.376	.401	.401	.401	.401	.401		.411	.411	
Top Punch	35353	35399	35399	37570	40048	40047	40048	40047	40048		41447	41447	
LR Top Punch	46516	46521	46516	46528	46530	46529	46530	46529	46530		46535	46535	
Description	Handgun Silhouette	Silhouette		Rifle	10mm Auto	10mm Auto	10mm Auto	10mm Auto	10mm Auto		41 Auto Petty Design	41 Auto Petty Design	

41 CAL. (continued)							44 CAL.				
No.	412	417	409	413	415	410	418	944	420	445	442
Designation	185gr. SWC	210gr. SWC	190gr. TC	210gr. TCBB	220gr. TCGC	220gr. FP	220gr. SWCBB	200gr. WC	200gr. TC	220gr. SWCBB	246gr. RN
Sizing Die	.411	.411	.411	.411	.411	.411	.411	.430	.430	.430	.430
Top Punch	41610	41610	41415	41415	41415	41415	41610	44944	44428	44191	44374
◆LR Top Punch	46536	46536	46534	46534	46534	46534	46536	46544	46542	46538	46540
Description						Pistol Silhouette	Bevel Base Keith Style	GAR Design	Jim Hubert Design		Standard 44 Spec. Bullet

											45 CAL.	
No.	441	440	439	429	424	428	431	430	432	433	063	062
Designation	240gr. SWC	240gr. SWCBB	240gr. SWCGC	240gr. FP	240gr. TCGC	240gr. TC	250gr. FPGC	265gr. FP	265gr. FPGC	300gr. FPGC	160gr. SPL	170gr. SPLBB
Sizing Die	.430	.430	.430	.430	.430	.430	.430	.430	.430	.430	.452	.452
Top Punch	44421	44421	44421	44191	44428	44428	44191	44191	44191	44191	45452	45452
◆LR Top Punch	46541	46541	46541	46538	46542	44542	46538	46538	46538	46538	46552	46552
Description	Standard Wt. 44 Mag Keith Style			Superb Long Range Bullet	GC Version of Popular 428	Most Popular Silhouette	444 Marlin	Superb Long Range Bullet		Silhouette	Behn Design	-V-MAXX .45 Behn Design

No.	065	130	131	066	068	069	058	265	067	456	457
Designation	180gr. SWCBB	185gr. SWC	185gr. SWCBB	180gr. SWC	200gr. SWCBB	200gr. SWC	215gr. SWCBB	210gr. RNWC	225gr. TCBB	225gr. RN	225gr. RNBB
Sizing Die	.452	.452	.452	.452	.452	.452	.452	.452	.452	.452	.452
Top Punch	45429	45421	45421	45429	45429	45429	45424	45265	45375	45701	45701
◆LR Top Punch	46551	46549	46549	46551	46551	46551	46550	46547	46548	46556	46556
Description	Lt. Wt. IPSC	Most Popular Lt. Target			Most Popular Combat Bullet		Bowling Pin Bullet	Best Feeding .45 ACP		Standard Round Nose	

					45 CAL. RIFLE								
No.	453	945	458	452	454	015	*017	*018	*019	*023	*021	*022	*020
Designation	225gr. WC	255gr. SWCGC	255gr. SWC	255gr. SWC	300gr. SWCGC	300gr. FP	350gr. FPGC	405gr. FP	465gr. FPGC	375gr. SP	405gr. SPGC	500gr. FP	540gr. FPGC
Sizing Die	.452	.452	.452	.455	.452	.458	.458	.458	.458	.458	.458	.458	.458
Top Punch	45424	45424	45424	45424	45424	45015	45015	45015	45015	45702	45702	45525	45525
◆LR Top Punch	46550	46550	46550	46550	46550	46545	46545	46545	46545	46557	46557	46553	46553
Description	Jan Libourel Design	For 45 Colt	For 45 Colt w/.452 Bore	For 45 Colt w/.454 Bore	Heavy .45 Colt & .454 Casull								

* Due to length, diameter or weight, the moulds indicated are available in "MAGNUM" mould blocks only.

◆ Designates Lyman/RCBS style Top Punches

Bullet Sizes & Weights – How to Vary Them

The bullet diameters and weights presented in this list are based on the use of Taracorp's Lawrence Magnum bullet alloy (2% tin, 6% antimony, 1/4% arsenic, 91.75% lead).

Bullet diameters and weights will vary considerably depending on the lead casting alloy used. This variation can be as much as 1/2% on the diameter, and 8% on the weight among the most commonly used casting alloys. For example, a .358-158 grain bullet might show a diameter variation of .002", and a 13 grain difference in weight.

Of the most commonly used alloys, wheel weights (.5% tin, 4% antimony, 95% lead) will produce bullets having the smallest diameter and heaviest weight, with such bullets running approximately 1/3% smaller in diameter and 3% heavier than bullets cast with Taracorp's metal. Linotype will produce bullets with the largest diameter and lightest weights. This alloy will

produce bullets approximately 1/10% larger and 3% lighter than Taracorp. Other alloys of tin and antimony, with antimony content above 5%, will produce bullets with diameters and weights falling between those cast from wheel weights and linotype.

Alloys containing little or no antimony will cast considerably smaller than wheel weights and in some cases will produce bullets too small for adequate sizing. Within the limitations given above, the weight and diameter of a cast bullet can be adjusted by varying the alloy's antimony content.

The size and weight of bullets of a given alloy will also vary according to casting temperature. Higher temperatures will result in greater shrinkage as the bullet cools, thereby producing a slightly smaller and lighter bullet than one cast of the same alloy at a lower temperature.

Gas Checks

SAECO has adopted the tapered form of gas check heel to minimize problems encountered with the use of various alloys and gas checks. SAECO bullets are designed to properly maintain the gas checks when cast with Lawrence Magnum Bullet Metal or linotype. Alloys producing smaller diameters may result in gas checks not seating properly. Bullet weights listed for gas check designs include the gas check weight.

Bevel Base Bullets

SAECO Bevel Base bullets have a slight bevel at the base of the bullet. This bevel helps guide the bullet into the cartridge case. A benefit of using bevel base bullets is that the case will require minimal bell-mouthing, and have a longer case life. Bevel base bullets are of course easier to seat.

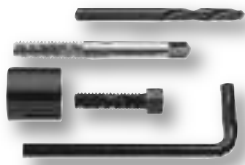

STUCK CASE REMOVAL KIT

Sooner or later everyone does it. Too little case lubricant (or using ordinary oil) and the case seizes in the resizing die. Usually, the rim pulls off and it is almost impossible to remove the stuck case without damaging the die. This case removal kit provides an easy solution to your problems. Instructions included.
 NO. 22000 **\$35.30**

CASE LUBE KIT

The most popular way to properly lubricate cases for resizing and case forming. The bottom side of the pad includes non-skid feet so it won't skate all over your bench when you are using it. Kit now includes a 2 oz. plastic bottle of Imperial Bio-Green.

Redding Case Lube Kit NO. 12012 ... **\$29.40**
 Case Lube Pad only NO. 12010 **\$20.75**
 Replacement Insert NO. 12007 **\$ 5.25**



New!
Model 15-P



PRECISION INSIDE CHAMFERING TOOL

This piloted chamfering tool features the perfect inside cutting angle of 15°. The pilot rod with attached accessory handle is adjustable for different cartridge lengths and insures the concentricity of the I.D. chamfer to the case mouth. Hardened precision ground flutes make clean, easy, chatterfree cuts. Accepts cases from .22 to .45 caliber.
 NO. 09030 **\$42.85**



CASE PREPARATION KIT

All the tools you need in one package for removing dirt and powder residue from the inside of case necks and primer pockets. Kit comes complete with accessory handle, large and small primer pocket cleaners and three (3) case neck brushes to handle all cartridges from .22 thru .45 caliber.

NO. 18000 **\$39.80**
 NO. 18005 Accessory Handle **11.65**
 NO. 99139 Lg. Pocket Cleaner **7.40**
 NO. 99138 Sm. Pocket Cleaner **7.40**
 NO. 99137 Lg. Neck Brush **5.50**
 NO. 99136 Med. Neck Brush **5.50**
 NO. 99135 Sm. Neck Brush **5.50**

CLASSIC DEBURRING TOOL

Removes burrs and bevels case mouths for easy bullet seating. Hardened precision ground flutes make clean, easy, chatterfree cuts. Accepts all cases from .17 to .45 caliber.
 NO. 09000 **\$38.70**



REDDING BRAND IMPERIAL SIZING DIE WAX

The original Imperial non-liquid sizing die wax, reformulated and manufactured by Redding. True to the original LeClear product of the 70's, even the classic green color. Packaged in 1 oz. tins.

ITEM NO. 21022 (1 oz. tin) **\$10.25**



Shooting Caps



Style "A"
 No. 99955

Low Profile, six panel heavy brushed twill cap. Fabric Strap Adjuster with Velcro®, front and rear embroidery. Color Tan /Dark Green **\$19.25** ea.



Style "C"
 No. 99960

Low Profile, six panel heavy brushed twill cap. Fabric Strap Adjuster with Velcro®, front and rear embroidery. Color: Dark Green **\$19.25** ea.



Style "B"
 No. 99965

Low Profile, six panel distressed twill unstructured cap. Fabric Strap Adjuster with brass buckle, front and rear embroidery. Color: Stone Washed Green **\$19.25** ea.



Style "D"
 No. 99950

Low Profile, six panel Advantage® Timber cap. Fabric Strap Adjuster with brass buckle, front and rear embroidery. Color: Advantage® Timber **\$20.30** ea.



Style "P"
 No. 99970

Low Profile, six panel chino twill unstructured cap. Fabric Strap Adjuster with brass buckle, front and rear embroidery. Color: Pink **\$19.25** ea.



Proceeds from Pink Cap supports Camp Good Days and Special Times Women's Oncology Programs

Official Redding Apparel now available, visit our website: www.redding-reloading.com



DIE SPACER KIT

For use with combination die sets and all 7/8-14 reloading dies to quickly compensate for case length or make a no-crimp adjustment without the need to move the lock rings. Kit includes three spacers: No-crimp or partial resizing, 44 Spl/44 Mag spacer, 38 Spl/357 Mag spacer.

NO. 80901 **\$15.30**



New!

PILOTED DEBURRING TOOL

Removes burrs and bevels case mouths for ease of bullet seating. The pilot rod feature is adjustable for different cartridge lengths and insures chamfer concentricity to the case mouth. Hardened precision ground flutes make clean, easy, chatterfree cuts. Accepts all cases from .22 to .475 caliber.

NO. 09060 **\$42.85**

POWDER FUNNEL

Nearly indestructible, super-tough

Lexan™. Fits most cartridge cases from .22 to .45 caliber.

Anti-static prevents powder from sticking. Not to be used with black powder.

NO. 13000 **\$10.50**



POWDER MEASURE RESERVOIRS

Replacement powder reservoirs are available in three sizes with or without caps. The smallest shown is the same as originally supplied on your Redding powder measure. The intermediate is 7" over-all length and the largest available is 10". These fit all models of Redding powder measures using a 2-1/8" O.D. reservoir.



NO. 99130 Original Reservoir **\$11.65**
 NO. 99333 Original Reservoir with cap..... **\$15.95**
 NO. 99157 7" Reservoir..... **\$15.95**
 NO. 99165 7" Reservoir w/ cap..... **\$19.80**
 NO. 99162 Long 10" Reservoir..... **\$19.80**
 NO. 99167 Long 10" Reservoir with cap... **\$23.40**
 NO. 99101 Reservoir cap..... **\$ 5.40**

BENCH STAND

For convenient bench-top mounting of Redding Powder Measures. Will also fit all other Powder Measures with 7/8-14 thread mounting. This bench stand is not threaded; it is secured with a lock ring which enables you to rotate the measure to any desired position and permits quick dump of the reservoir.

NO. 06000 **\$57.85**



Interesting Note:

Our tests have demonstrated that powder measures show slightly improved accuracy when mounted in a bench stand securely fastened to a solid bench.

DOUBLE "C" CLAMP

Now available in two

sizes. The

original

SAECO

Double "C"

Clamp was

designed as

a convenient

way to secure the SAECO lubrisizer to a bench top. The newest model is the ideal size for clamping the Redding powder measure stand and case trimmer to a bench top. Both units will accommodate a bench thickness of up to 2-1/4". May be used to mount any number of tools. Handy items for any reloading room.

NO. 30120 Lubrisizer Clamp
(2-3/8" inside fingers) **\$39.80**

NO. 30520 Bench Stand/Trimmer Clamp
(1-5/8" inside fingers) **\$39.80**

Note: NO. 30520 also fits Case Neck Gauge



INGOT MOULDS

The SAECO cast iron ingot mould will produce four easy-to-handle ingots. A perfect way to store blended alloys.

NO. 23000...**\$36.00**



Spare Parts

The spare parts listed represent only the most commonly requested service parts. For price and availability of items not listed, please consult factory.

NO. RS-1 STANDARD POWDER SCALE

Pan **\$11.25**

Pan Hook **7.65**

Main Bearing** **11.25**

Clean & recalibration** **20.00**

NO. 2 MASTER POWDER SCALE

Pan **11.25**

Pan Hook Assembly **12.65**

Main Bearing** **11.25**

Beam Assembly** **57.65**

Clean & recalibration** **20.00**

**Scale must be returned to factory for replacement, cleaning and recalibration.

NO. 3 & 3BR POWDER MEASURES

Drop Tube **7.65**

Lock Screw **4.35**

Cap only **5.40**

Reservoir Screws (2) **1.25**

3BR & BR-30 Operating Handle **19.40**

Drop Tube Adapter .17 & .20 cal. **13.95**

Powder Baffle **7.85**

NO. 1400 CASE TRIMMER

TiN Cutter (specify standard or .17 cal.) ... **36.25**

Shaft Only **15.30**

Collet **26.80**

Collet, 470 Nitro **26.80**

Pilots (Solid Shank Style) **7.55**

Cutter Sharpening **10.60**

PARTS FOR OLD STYLE TRIMMERS

(Models 13, 14, & 14K)

Cutter Blade (Square or "V") specify **8.70**

Pilots (No. 15 Split Shank) **8.70**

ULTRAMAG & BOSS PRESS

Primer Arm Assembly **26.25**

Primer Pin (Lg. or Sm.) specify **3.25**

Primer Pin Sleeve (Lg. or Sm.) specify **3.25**

Primer Pin Spring **1.25**

Boss Primer Catcher **10.75**

T-7 TURRET PRESS & BIG BOSS

Turret, seven station w/bushing **120.25**

Primer Arm Assembly **26.25**

Primer Pin (Lg. or Sm.) specify **3.25**

Primer Pin Sleeve (Lg. or Sm.) specify **3.25**

Primer Pin Spring **1.25**

Big Boss Primer Catcher **10.75**

NO. 12 CASE LUBE PAD

Foam Pad Insert **5.25**

Adhesive Non-skid Feet (4) **1.70**

NO. 10 MISCELLANEOUS DIE PARTS

Die Spacer Rings- each **6.25**

Plastic Die Box **9.70**

Small Lock Rings **3.40**

Body Lock Ring 7/8"-14 **5.65**

Decap Pins (Pkg. of 10) lg. or sm. **7.65**

Lifetime Warranty

All Redding Reloading Equipment has been carefully inspected prior to shipment and is fully warranted to be free from defects in materials and workmanship for life. Imperial and SAECO products now manufactured by Redding carry the same warranty. Any product or parts which prove to be defective will be replaced or repaired without charge if returned prepaid to the factory.

Note: We reserve the right to decline responsibility where misuse or careless handling is evident or where repairs or modifications have been made or attempted by others.



RELOADING EQUIPMENT

1089 Starr Road, Cortland, NY 13045
(607) 753-3331 • FAX (607) 756-8445
Website: <http://www.redding-reloading.com>
E-mail: techline@redding-reloading.com

